

Wire Basket Trays

PRODUCT FAMILY SPECIFICATION SHEETS

BFR/BFR

BEBasor
CABLE TRAY SPECIALIST

BASORFIL BF2R-H2"

PRODUCT IMAGE

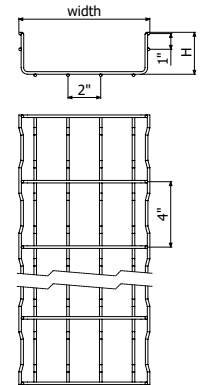

CHARACTERISTICS

- 2" Tray depth
- Electrozinc finish only
- Field modify tray with bolt cutters
- Waved wire profile reduces tray twisting
- Pre-Installed splices

DESCRIPTION	HEIGHT (H)		WIDTH (W)		LENGTH (L)		REF.				
	in	mm	in	mm	ft	m	ZN	Black	White	Red	Yellow
BF2R 2"x2"	2"	65	2"	60	10'	3	2/7389	U/0299	U/0600	U/0400	U/0500
BF2R 4"x2"	2"	65	4"	100	10'	3	2/7248	U/0300	U/0601	U/0401	U/0501
BF2R 6"x2"	2"	65	6"	150	10'	3	2/7249	U/0301	U/0602	U/0402	U/0502
BF2R 8"x2"	2"	65	8"	200	10'	3	2/7250	U/0302	U/0603	U/0403	U/0503
BF2R 12"x2"	2"	65	12"	300	10'	3	2/7251	U/0303	U/0604	U/0404	U/0504
BF2R 16"x2"	2"	65	16"	400	10'	3	2/7394	U/0304	U/0605	U/0405	U/0505
BF2R 18"x2"	2"	65	18"	450	10'	3	2/9989	U/0305	U/0606	U/0406	U/0506
BF2R 20"x2"	2"	65	20"	500	10'	3	2/7395	U/0306	U/0607	U/0407	U/0507
BF2R 24"x2"	2"	65	24"	600	10'	3	2/7396	U/0307	U/0608	U/0408	U/0508

*Measurement is nominal

DESCRIPTION	TRAY FILL		SAFE WORKING LOAD		
	in	mm	ZN		CENTER SPlice
			lbs/ft	kg/m	units
BF2R 2"x2"	3.57"	23	15	23	0
BF2R 4"x2"	7.29"	47	30	45	0
BF2R 6"x2"	11.63"	75	30	45	0
BF2R 8"x2"	15.81"	102	30	45	0
BF2R 12"x2"	24.34"	157	30	45	1
BF2R 16"x2"	32.86"	212	30	45	1
BF2R 18"x2"	41.39"	267	37	55	2
BF2R 20"x2"	41.39"	267	37	55	2
BF2R 24"x2"	49.91"	322	37	55	2

ZN - Electrozinc coating

BASORFIL BF2R-H4"

PRODUCT IMAGE

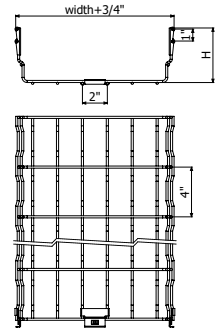

CHARACTERISTICS

- 4" Tray depth
- Electrozinc & Painted finish options
- Field modify tray with bolt cutters
- Waved wire profile reduces tray twisting
- Pre-Installed splices

DESCRIPTION	HEIGHT (H)		WIDTH (W)		LENGTH (L)		REF.				
	in	mm	in	mm	ft	m	ZN	Black	White	Red	Yellow
BF2R 4"x4"	4"	105	4"	100	10'	3	2/7914	U/0308	U/0609	U/0409	U/0509
BF2R 6"x4"	4"	105	6"	150	10'	3	2/7915	U/0309	U/0610	U/0410	U/0510
BF2R 8"x4"	4"	105	8"	200	10'	3	2/7397	U/0310	U/0611	U/0411	U/0511
BF2R 12"x4"	4"	105	12"	300	10'	3	2/7398	U/0311	U/0612	U/0412	U/0512
BF2R 16"x4"	4"	105	16"	400	10'	3	2/7399	U/0312	U/0613	U/0413	U/0513
BF2R 18"x4"	4"	105	18"	450	10'	3	2/9990	U/0313	U/0614	U/0414	U/0514
BF2R 20"x4"	4"	105	20"	500	10'	3	2/7400	U/0314	U/0615	U/0415	U/0515
BF2R 24"x4"	4"	105	24"	600	10'	3	2/7401	U/0315	U/0616	U/0416	U/0516

*Measurement is nominal

DESCRIPTION	TRAY FILL		SAFE WORKING LOAD		
	in	mm	ZN		CENTER SPLICE
			lbs/ft	kg/m	units
BF2R 4"x4"	14.42"	93	30	45	0
BF2R 6"x4"	21.63"	139.5	30	45	0
BF2R 8"x4"	28.83"	186	40	60	0
BF2R 12"x4"	45.11"	291.03	40	60	1
BF2R 16"x4"	61.38"	396	47	70	1
BF2R 18"x4"	67.77"	436.55	47	70	-
BF2R 20"x4"	77.76"	501.03	47	70	2
BF2R 24"x4"	93.93"	606	47	70	2

ZN - Electrozinc coating

BASORFIL BF2R-P H6"

PRODUCT IMAGE

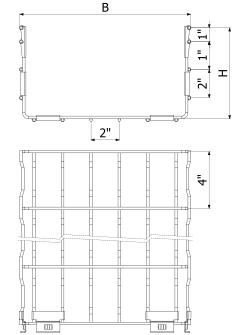
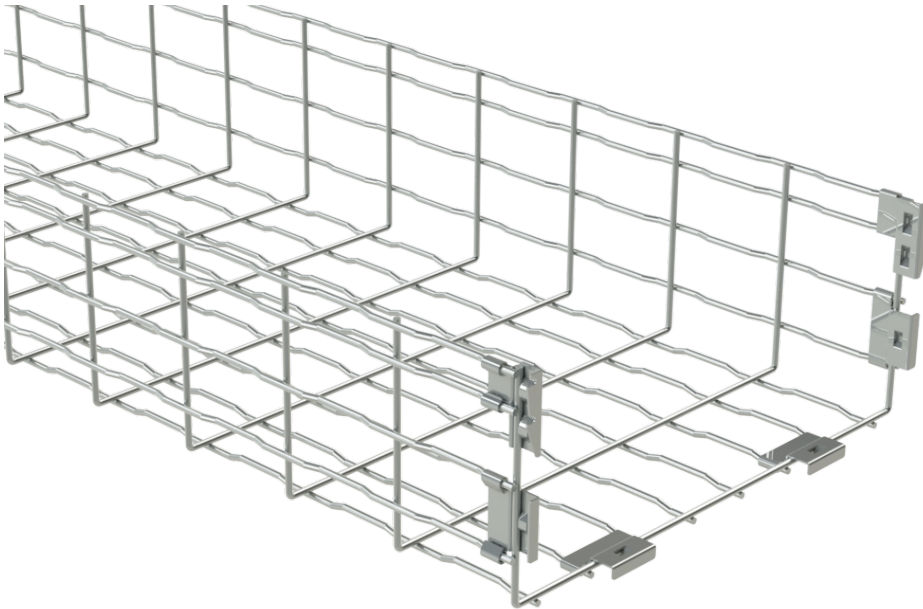

CHARACTERISTICS

6" Tray depth
8" .. 24" Tray width
Wire-Mesh trays for extra hyper scale data projects
Waved wire profile reduces tray twisting
Pre-Installed splices



DESCRIPTION	HEIGHT (H)		WIDTH (W)		LENGTH (L)		REF.		
	in	mm	in	mm	ft	m	ZN	Black	White
BF2R-P 8"x6"	6"	150	8"	200	10'	3	225201	U/1351	U/1651
BF2R-P 12"x6"	6"	150	12"	300	10'	3	225202	U/1352	U/1652
BF2R-P 16"x6"	6"	150	16"	400	10'	3	225203	U/1353	U/1653
BF2R-P 18"x6"	6"	150	18"	450	10'	3	225204	U/1354	U/1654
BF2R-P 20"x6"	6"	150	20"	500	10'	3	225205	U/1355	U/1655
BF2R-P 24"x6"	6"	150	24"	600	10'	3	225206	U/1356	U/1656

DESCRIPTION	TRAY FILL		SAFE WORKING LOAD	
	in ²	cm ²	lbs/ft	kg/m
BF2R-P 8"x6"	44.33	1125.98	49	73
BF2R-P 12"x6"	68.20	1732.28	49	73
BF2R-P 16"x6"	92.07	2338.58	58	86
BF2R-P 20"x6"	115.94	2944.88	119	177
BF2R-P 24"x6"	139.81	3551.17	127	188

ZN - Electrozinc coating

BASORFIL BFR-H6"

PRODUCT IMAGE

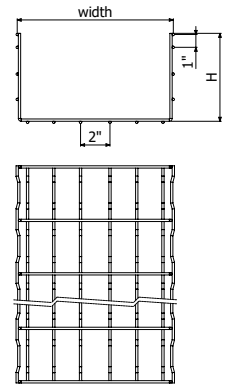

CHARACTERISTICS

6" Tray depth
Field modify tray with bolt cutters
Waved wire profile reduces tray twisting
Use a Bolt-Staple Set or Quick Splice to splice tray sections

DESCRIPTION	HEIGHT (H)		WIDTH (W)		LENGTH (L)		REF.							
	in	mm	in	mm	ft	m	ZN	HDG	i304	i316	Black	White	Red	Yellow
BFR 8"x6"	6"	150	8"	200	10'	3	2/9549	2/9554	UR	UR	U/0316	U/0617	U/0417	U/0517
BFR 12"x6"	6"	150	12"	300	10'	3	2/9550	2/9555	UR	UR	U/0317	U/0618	U/0418	U/0518
BFR 16"x6"	6"	150	16"	400	10'	3	2/9551	2/9556	UR	UR	U/0318	U/0619	U/0419	U/0519
BFR 18"x6"	6"	150	18"	450	10'	3	2/9991	-	UR	UR	U/0319	U/0620	U/0420	U/0520
BFR 20"x6"	6"	150	20"	500	10'	3	2/9552	2/9557	UR	UR	U/0320	U/0621	U/0421	U/0521
BFR 24"x6"	6"	150	24"	600	10'	3	2/9553	2/9558	UR	UR	U/0321	U/0622	U/0422	U/0522

*Measurement is nominal

DESCRIPTION	TRAY FILL		SAFE WORKING LOAD					
	in ²	cm ²	ZN		HDG		i304/i316	
			lbs/ft	kg/m	lbs/ft	kg/m	lbs/ft	kg/m
BFR 8"x6"	44.33	1125.98	49	73	49	73	51	76
BFR 12"x6"	68.20	1732.28	49	73	49	73	51	76
BFR 16"x6"	92.07	2338.58	58	86	58	86	55	83
BFR 20"x6"	115.94	2944.88	58	86	58	86	55	83
BFR 24"x6"	139.81	3551.17	58	86	58	86	-	-

ZN - Electro zinc coating HDG - Hot Dip Galvanized Steel i304/i316 - Stainless Steel AISI i304/i316

BASORFIL BF

PRODUCT IMAGE

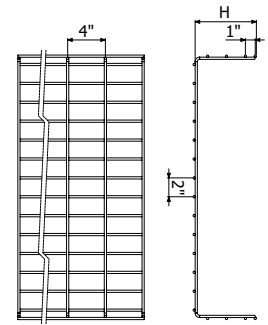
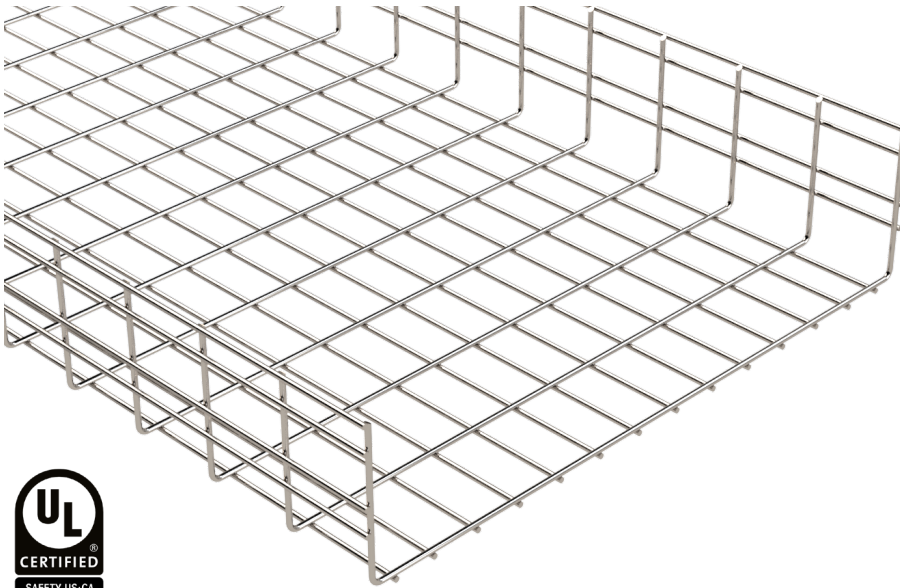

CHARACTERISTICS

Length = 10FT/3M

DESCRIPTION	WIDTH (W)		WEIGHT		REF.		
	in	mm	lbs/unit	kg/ud	ZN	Black	White
Wire Mesh Cable Tray BF 28"x6" EZ	28"	711.2	36.24	16.45	2/18784	Upon Request	Upon Request
Wire Mesh Cable Tray BF 36"x2" EZ	36"	914.4	42.92	19.50	2/18785		
Wire Mesh Cable Tray BF 36"x4" EZ	36"	914.4	42.92	19.50	2/18786		
Wire Mesh Cable Tray BF 36"x6" EZ	36"	914.4	42.92	19.50	2/18787		

BASORFIL BFR-H1.5"

PRODUCT IMAGE

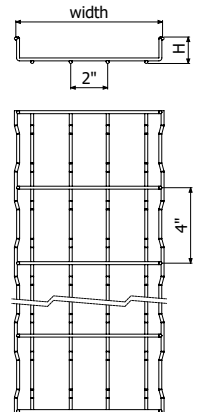
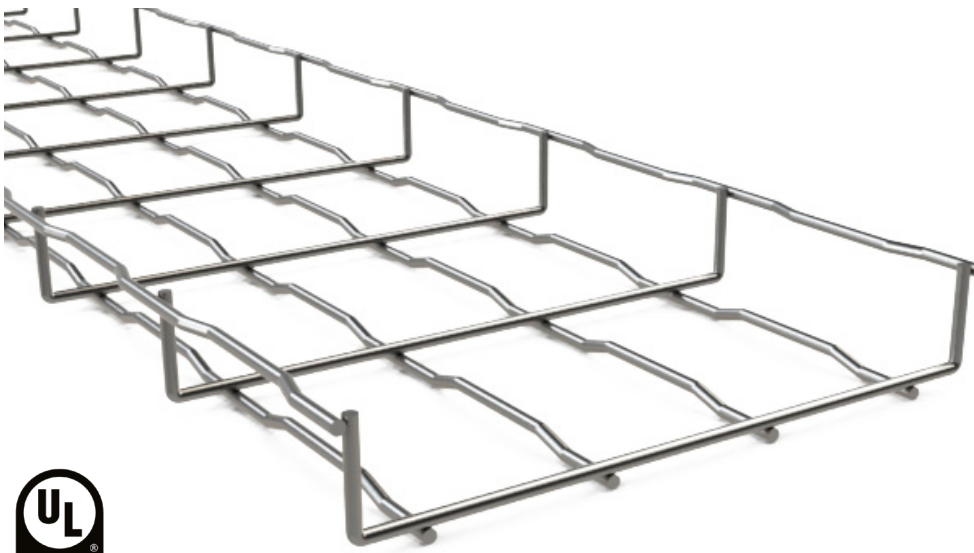

CHARACTERISTICS

1.5" Tray depth
Field modify tray with bolt cutter
Waved wire profile reduces tray twisting
Use a Bolt-Staple set or Quick Splice to splice tray sections

DESCRIPTION	HEIGHT (H)		WIDTH (W)		LENGTH (L)		REF.			
	in	mm	in	mm	ft	m	ZN	HDG	i304	i316
BFR - 4"x1.5"	1.5"	35	4"	100	10'	3	2/3616	2/0286	2/0303	2/7415
BFR - 6"x1.5"	1.5"	35	6"	150	10'	3	2/3617	2/0287	2/0304	2/7416
BFR - 8"x1.5"	1.5"	35	8"	200	10'	3	2/3618	2/0288	2/0305	2/7417
BFR - 12"x1.5"	1.5"	35	12"	300	10'	3	2/3619	2/0289	2/0306	2/7418

DESCRIPTION	TRAY FILL		SAFE WORKING LOAD			
	in ²	cm ²	HDG		i304/i316	
			lbs/ft	kg/m	lbs/ft	kg/m
BFR - 4"x1.5"	4.18	270	12	18	17	25
BFR - 6"x1.5"	6.51	420	12	18	17	25
BFR - 8"x1.5"	8.99	580	12	18	17	25
BFR - 12"x1.5"	13.8	890	12	18	17	25

HDG - Hot Dip Galvanized Steel

i304/i316 - Stainless Steel AISI i304/i316

BASORFIL BFR-H2"

PRODUCT IMAGE

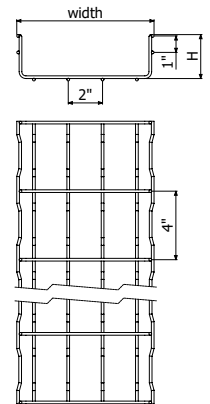

CHARACTERISTICS

2" Tray depth
Field modify tray with bolt cutters
Waved wire profile reduces tray twisting
Use a Bolt-Staple set or Quick Splice to splice tray sections

DESCRIPTION	HEIGHT (H)		WIDTH (W)		LENGTH (L)		REF.		
	in	mm	in	mm	ft	m	HDG	i304	i316
BFR 2"x2"	2"	65	2"	60	10'	3	2/0290	2/0307	2/7419
BFR 4"x2"	2"	65	4"	100	10'	3	2/0291	2/0308	2/7420
BFR 6"x2"	2"	65	6"	150	10'	3	2/0292	2/0309	2/7421
BFR 8"x2"	2"	65	8"	200	10'	3	2/0293	2/0310	2/7422
BFR 12"x2"	2"	65	12"	300	10'	3	2/0294	2/0311	2/7423
BFR 16"x2"	2"	65	16"	400	10'	3	2/0295	2/0312	2/7424
BFR 18"x2"	2"	65	18"	450	10'	3	2/4957	-	-
BFR 20"x2"	2"	65	20"	500	10'	3	2/0296	2/0313	2/7425
BFR 24"x2"	2"	65	24"	600	10'	3	2/0297	2/0314	2/7426

*Measurement is nominal

DESCRIPTION	TRAY FILL		SAFE WORKING LOAD			
	in ²	cm ²	HDG		i304/i316	
			lbs/ft	kg/m	lbs/ft	kg/m
BFR 2"x2"	44.33	1125.98	49	73	51	76
BFR 4"x2"	68.20	1732.28	49	73	51	76
BFR 6"x2"	92.07	2338.58	58	86	55	83
BFR 8"x2"	115.94	2944.88	58	86	55	83
BFR 12"x2"	139.81	3551.17	58	86	-	-
BFR 16"x2"	68.20	1732.28	49	73	51	76
BFR 18"x2"	92.07	2338.58	58	86	55	83
BFR 20"x2"	115.94	2944.88	58	86	55	83
BFR 24"x2"	139.81	3551.17	58	86	-	-

HDG - Hot Dip Galvanized Steel

i304/i316 - Stainless Steel AISI i304/i316

BASORFIL BFR-H4"

PRODUCT IMAGE

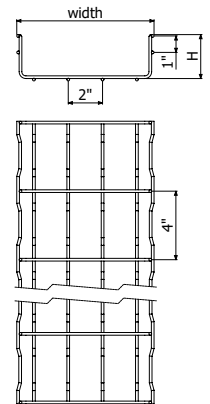
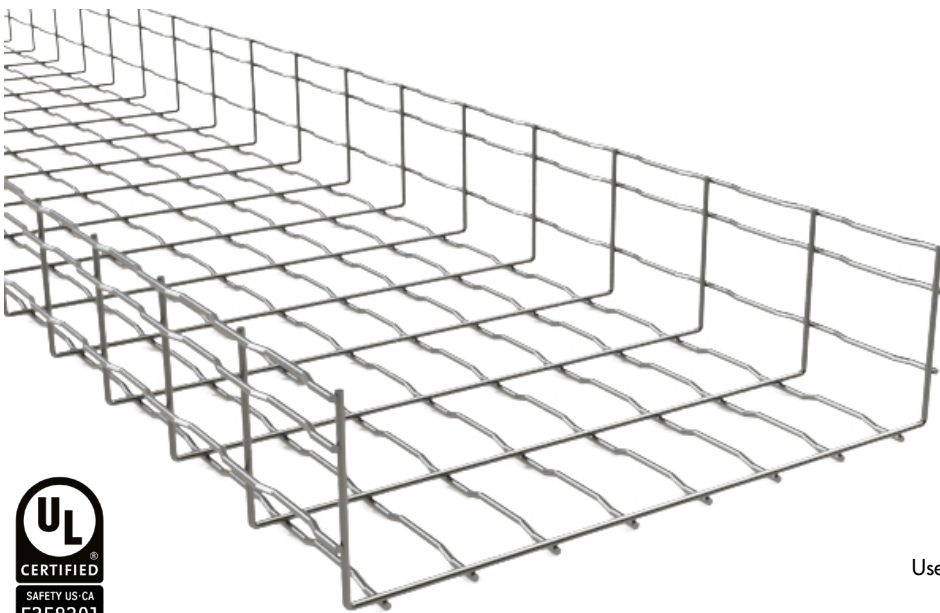

CHARACTERISTICS

4" Tray depth
Field modify tray with bolt cutter
Waved wire profile reduces tray twisting
Use a Bolt-Staple set or Quick Splice to splice tray sections

DESCRIPTION	HEIGHT (H)		WIDTH (W)		LENGTH (L)		REF. i304
	in	mm	in	mm	ft	m	
BFR 8"x4"	4"	105	8"	200	10'	3	2/7427
BFR 12"x4"	4"	105	12"	300	10'	3	2/7428
BFR 16"x4"	4"	105	16"	400	10'	3	2/7429
BFR 18"x4"	4"	105	18"	450	10'	3	-
BFR 20"x4"	4"	105	20"	500	10'	3	2/7430
BFR 24"x4"	4"	105	24"	600	10'	3	2/7431

*Measurement is nominal

DESCRIPTION	TRAY FILL		SAFE WORKING LOAD	
	in ²	cm ²	lbs/ft	kg/m
BFR 8"x4"	29.92	193.03	51	76
BFR 12"x4"	46.04	297.03	51	76
BFR 16"x4"	62.16	401.03	55	83
BFR 18"x4"	69.05	445.59	55	83
BFR 20"x4"	78.28	505.03	55	83
BFR 24"x4"	94.40	609.03	55	83

i304/i316 - Stainless Steel AISI i304/i316

BASORFIL E-BFR H4"

PRODUCT IMAGE

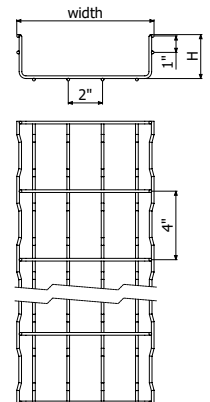

CHARACTERISTICS

4" Tray depth
Field modify tray with bolt cutter
Waved wire profile reduces tray twisting
Use a Bolt-Staple set or Quick Splice to splice tray sections

DESCRIPTION	HEIGHT (H)		WIDTH (W)		LENGTH (L)		REF.	
	in	mm	in	mm	ft	m	ZN	HDG
E-BFR 8"x4"	4"	105	8"	200	10'	3	2/0298	2/0315
E-BFR 12"x4"	4"	105	12"	300	10'	3	2/0299	2/0316
E-BFR 16"x4"	4"	105	16"	400	10'	3	2/0300	2/0317
E-BFR 18"x4"	4"	105	18"	450	10'	3	2/9548	-
E-BFR 20"x4"	4"	105	20"	500	10'	3	2/0301	2/0318
E-BFR 24"x4"	4"	105	24"	600	10'	3	2/0302	2/0319

*Measurement is nominal

BFR/BF2R H2" Cover

PRODUCT IMAGE

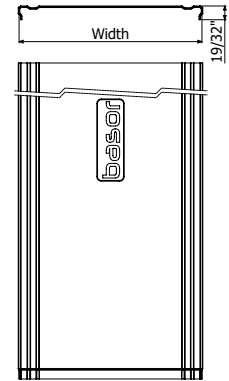
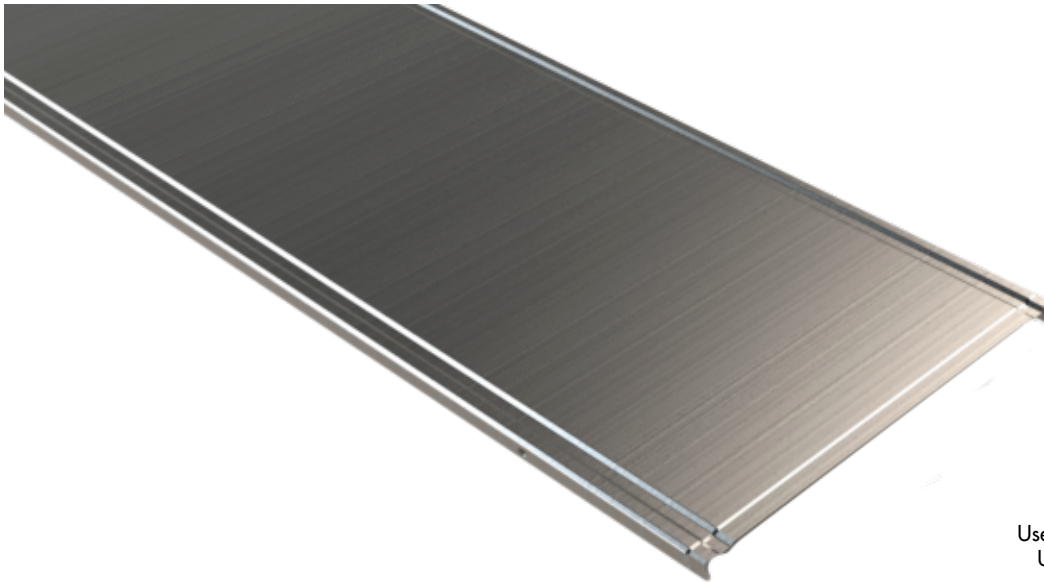

CHARACTERISTICS

Use with ERE BFR and BF2R H2" BasorFil Tray
Use PTBFR Hold Down Clips to attach covers
Covers are 5' in length

DESCRIPTION	WIDTH (W)		REF.						
	in	mm	ZN	HDG	i304	Black	White	Red	Yellow
BFR Cover for Basket Tray 4"	4"	100	2/1312	2/1321	2/4560	U/1313	U/1605	U/1404	U/1504
BFR Cover for Basket Tray 6"	6"	150	2/1313	2/1322	2/5123	U/1314	U/1606	U/1405	U/1505
BFR Cover for Basket Tray 8"	8"	200	2/1314	2/1323	2/4561	U/1315	U/1607	U/1406	U/1506
BFR Cover for Basket Tray 12"	12"	300	2/1316	2/1325	2/4716	U/1316	U/1608	U/1407	U/1507
BFR Cover for Basket Tray 16"	16"	400	2/1317	2/1326	2/4931	U/1317	U/1609	U/1408	U/1508
BFR Cover for Basket Tray 18"	18"	450	U/0023	-	-	U/1318	U/1610	U/1409	U/1509
BFR Cover for Basket Tray 20"	20"	500	2/1318	2/1327	2/4562	U/1319	U/1611	U/1410	U/1510
BFR Cover for Basket Tray 24"	24"	600	2/1319	2/1328	2/5357	U/1320	U/1612	U/1411	U/1511

ZN - Electrozinc coating HDG - Hot Dip Galvanized Steel i304/i316 - Stainless Steel AISI i304/i316



BFR/BF2R H4"/6" Cover

PRODUCT IMAGE

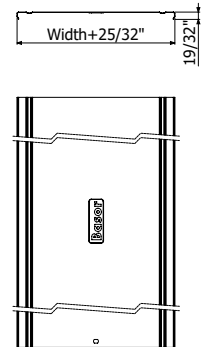
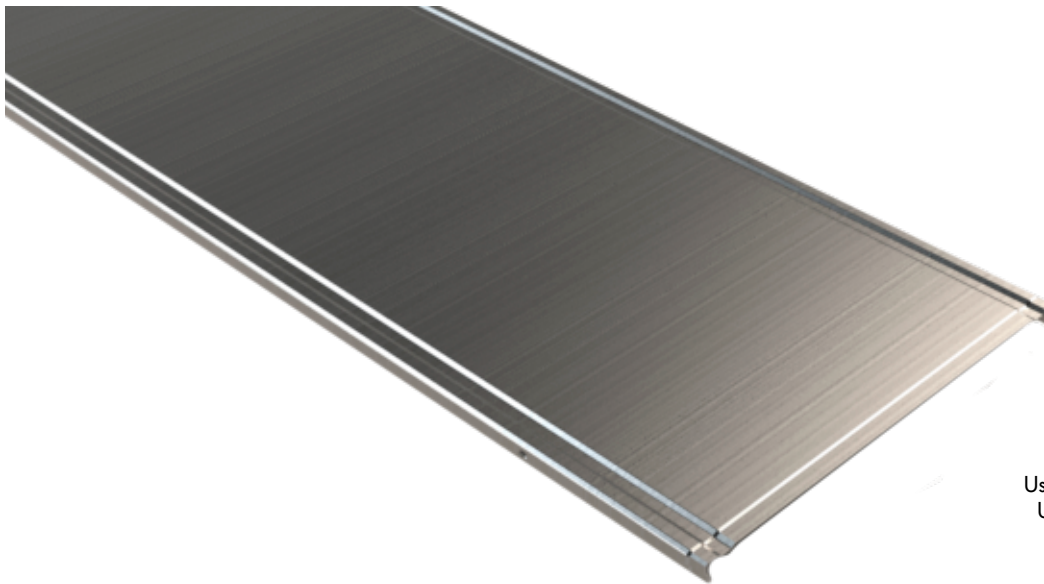

CHARACTERISTICS

Use with BFR and BF2R H4"/6" BasorFil Tray
Use PTBFR Hold Down Clips to attach covers
Covers are 5' in length

DESCRIPTION						
	PG	HDG	Black	White	Red	Yellow
E-BFR/BF2R H4"/6" Cover for Basket Tray 4"	2/8811	2/8818	U/1305	U/1601	U/0496	U/0596
E-BFR/BF2R H4"/6" Cover for Basket Tray 6"	2/8812	2/8819	U/1321	U/1613	U/1412	U/1512
E-BFR/BF2R H4"/6" Cover for Basket Tray 8"	2/8813	2/8820	U/1322	U/1614	U/1413	U/1513
E-BFR/BF2R H4"/6" Cover for Basket Tray 12"	2/8814	2/8821	U/1323	U/1615	U/1414	U/1514
E-BFR/BF2R H4"/6" Cover for Basket Tray 16"	2/8815	2/8822	U/1324	U/1616	U/1415	U/1515
E-BFR/BF2R H4"/6" Cover for Basket Tray 18"	U/0024	-	U/1300	U/1602	U/1416	U/0597
E-BFR/BF2R H4"/6" Cover for Basket Tray 20"	2/8816	2/8823	U/1325	U/1617	U/1417	U/1516
E-BFR/BF2R H4"/6" Cover for Basket Tray 24"	2/8817	2/8824	U/1326	U/1618	U/1418	U/1517

PG - Pregalvanized HDG - Hot Dip Galvanized Steel



Cover Hold Down Clip

PRODUCT IMAGE

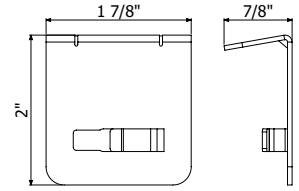

CHARACTERISTICS

Used to attach covers to BasorFil Tray
Bend-over tabs attach cover without bolting

DESCRIPTION	REF.					
	PG	i304	Black	White	Red	Yellow
BFR Cover for Basket Tray 4"	2/10253	2/10254	U/1301	U/1600	U/0495	U/0595

PG - Pregalvanized i304 - Stainless Steel AISI i304

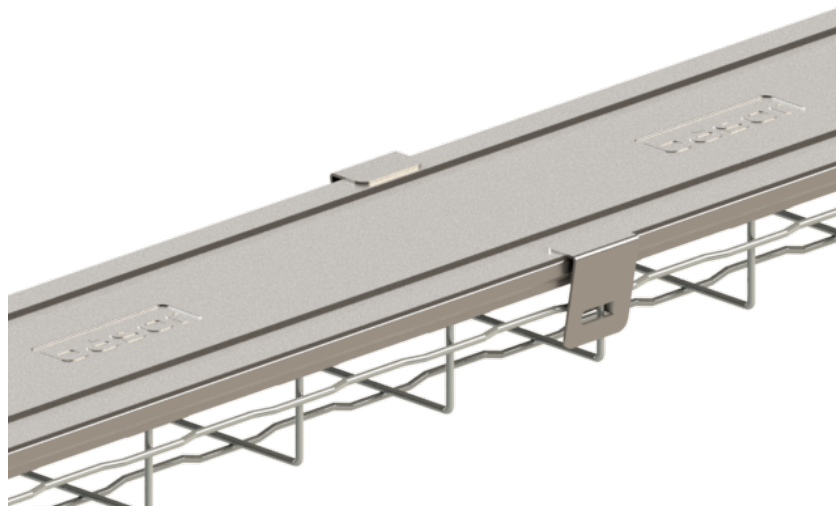

Solid Bottom Insert

PRODUCT IMAGE

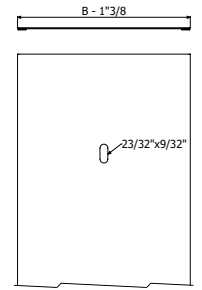
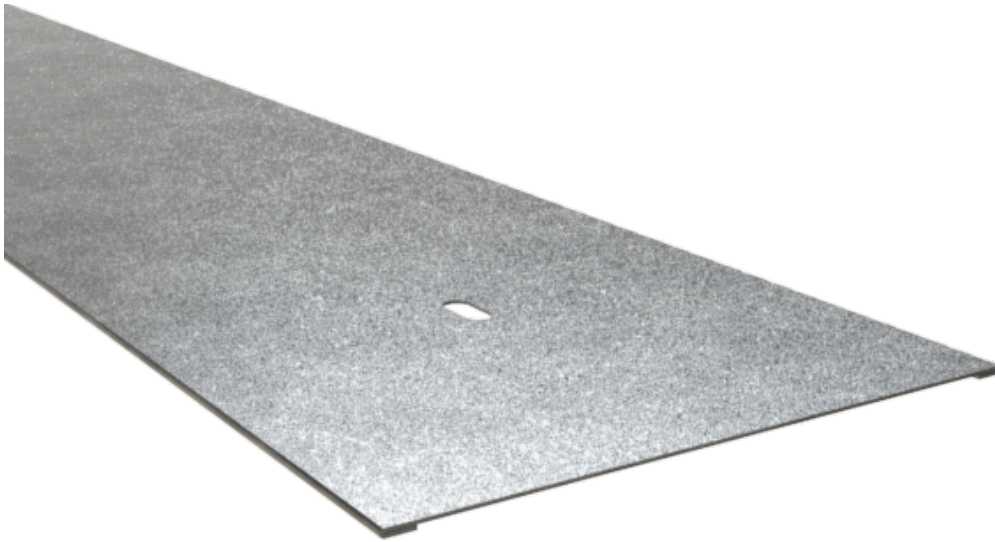

CHARACTERISTICS

Creates a smooth base inside BasorFil tray for sensitive cable types

DESCRIPTION	REF.				
	PG	Black	White	Red	Yellow
Solid Bottom 4"	SB4	U/0346	U/0647	U/0447	U/0547
Solid Bottom 6"	SB6	U/0346	U/0647	U/0447	U/0548
Solid Bottom 8"	SB8	U/0346	U/0647	U/0447	U/0549
Solid Bottom 12"	SB12	U/0346	U/0647	U/0447	U/0550
Solid Bottom 16"	SB16	U/0346	U/0647	U/0447	U/0551
Solid Bottom 18"	SB18	U/0346	U/0647	U/0447	U/0552
Solid Bottom 20"	SB20	U/0346	U/0647	U/0447	U/0553
Solid Bottom 24"	SB24	U/0346	U/0647	U/0447	U/0554

PG - Pregalvanized



Kit FSBFR - Solid Bottom

PRODUCT IMAGE

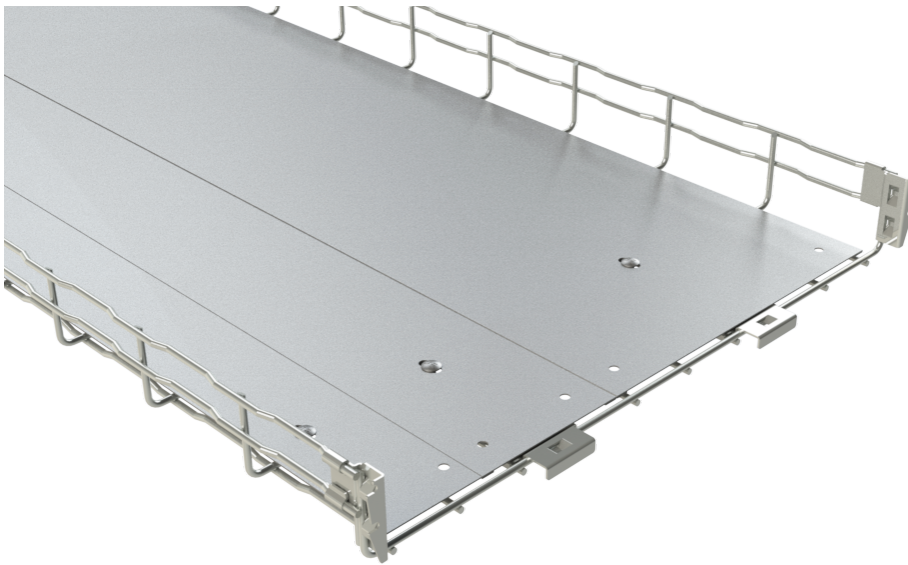

CHARACTERISTICS

Creates a smooth base inside BasorFil tray for sensitive cable types

DESCRIPTION	Parts			REF.
	FS4"	FS6"	FS12"	PG
KIT FS4"	1X	-	-	U/1660
KIT FS6"	-	1X	-	U/1662
KIT FS8"	2X	-	-	U/1663
KIT FS12"	-	-	1X	U/1664
KIT FS16"	1X	-	1X	U/1665
KIT FS18"	-	1X	1X	U/1666
KIT FS20"	2X	-	1X	U/1667
KIT FS24"	-	-	2X	U/1668

PG - Pregalvanized

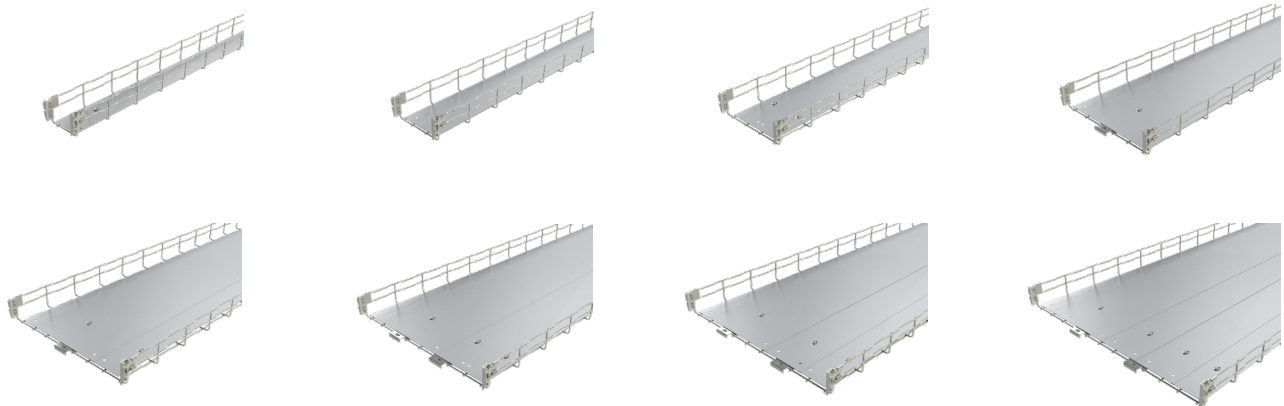

PVC Liner

PRODUCT IMAGE

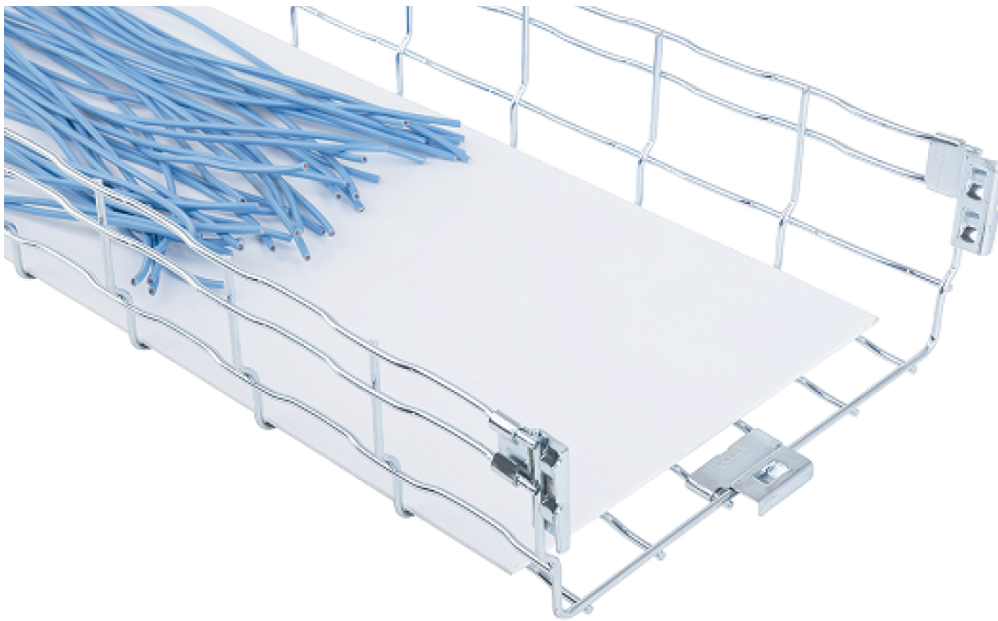

CHARACTERISTICS

Length = 10FT / 3m

DESCRIPTION	WIDTH (W)		LENGTH (L)		WEIGHT		REF.
	in	mm	ft	m	lbs/unit	kg/ud	PVC
Wider Liner 6"	6	150	200	61	21	10	Upon Request
Wider Liner 12"	12	300	200	61	28	13	
Wider Liner 18"	16	400	200	61	46	21	
Wider Liner 24"	24	600	200	61	55	25	
Wider Liner 6" (Bottom only)	6	150	200	61	7	3	Upon Request
Wider Liner 12" (Bottom only)	12	300	200	61	21	10	
Wider Liner 18" (Bottom only)	16	400	200	61	33	15	
Wider Liner 20" (Bottom only)	20	500	200	61	37	17	
Wider Liner 24" (Bottom only)	24	600	200	61	44	20	

PS - Divider Strip

PRODUCT IMAGE

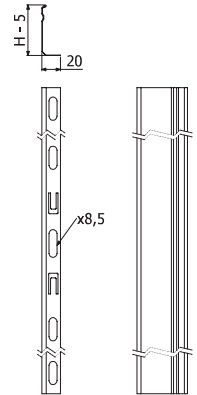
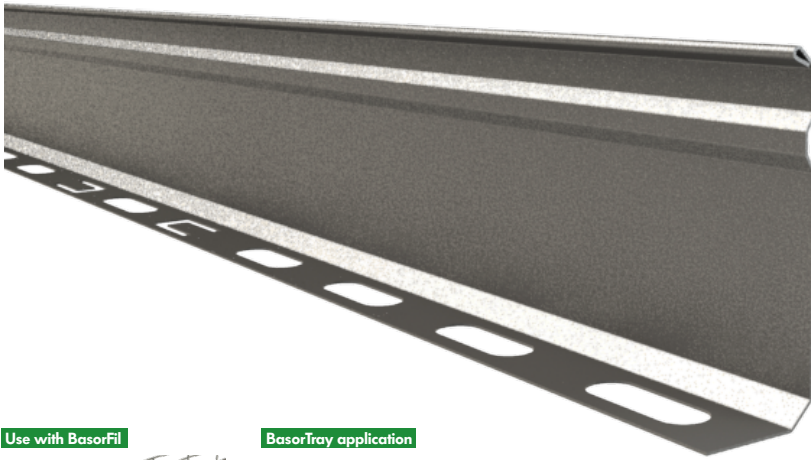

Use with BasorFil

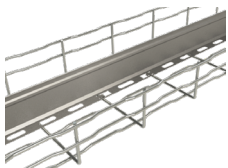

BasorTray application

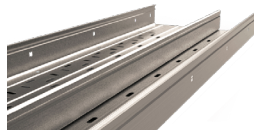

CHARACTERISTICS

Keeps cables separated in a single tray
 Use in BasorFil and BasorTray
 Attach to BasorFil with B1 Bolt Set and BF Washer Every 20"
 Attach to BasorTray with B1 Bolt Set every 20"
 Easily field modified

DESCRIPTION	HEIGHT (H)		LENGTH (L)		REF.							
	in	mm	ft	m	GS	HDG	i304	i316	Black	White	Red	Yellow
PS 35	1.4"	35	10'	3	2/3476	2/3479	2/11227	UR	U/0322	U/0623	U/0423	U/0523
PS 60	2.4"	60	10'	3	2/0266	2/3480	2/3645	UR	U/0323	U/0624	U/0424	U/0524
PS 80	3.25"	80	10'	3	2/3477	2/3481	2/11228	UR	U/0324	U/0625	U/0425	U/0525
PS 100	4"	100	10'	3	2/3478	2/3482	2/5118	UR	U/0325	U/0626	U/0426	U/0526
PS 150	6"	150	10'	3	2/9852	2/4592	UR	UR	U/0326	U/0627	U/0427	U/0527

GS - Pre-Galvanized Steel HDG - Hot Dip Galvanized Steel i304/i316 - Stainless Steel AISI i304/i316

MOUNTING OPTIONS

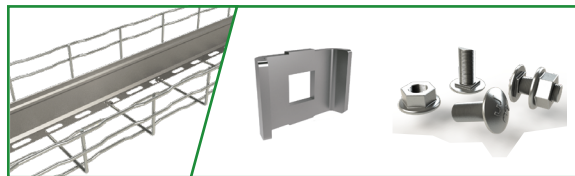

BasorFil

BF Washer + B1 Bolt Set

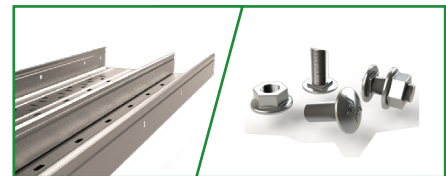

BasorTray

B1 Bolt Set

Bolt-Staple Set

PRODUCT IMAGE

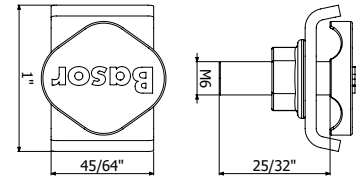

CHARACTERISTICS

Set includes BF Bolt-Nut Set and BF Washer
Use to splice all BsoFil tray

DESCRIPTION	REF.							
	ZN	HDG	i304	i316	Black	White	Red	Yellow
BF Bolt-Staple Set	2/4364	2/4360	2/4915	2/5358	U/0329	U/0630	U/0430	U/0530

ZN - Electrozinc Coating HDG - Hot Dip Galvanized Steel i304/i316 - Stainless Steel AISI i304/i316

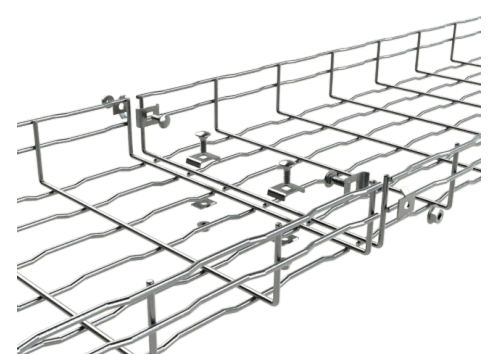
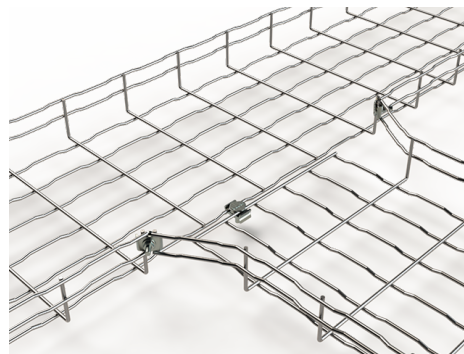
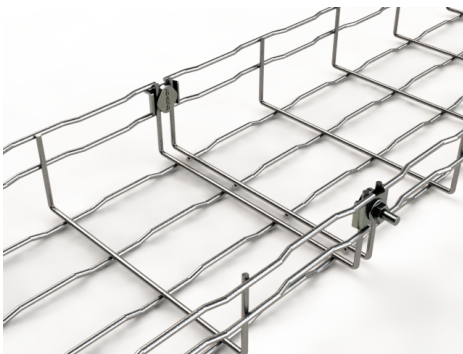

BF Bolt Nut Set

PRODUCT IMAGE



CHARACTERISTICS

Used to attach tray to supports

DESCRIPTION	REF.							
	ZN	HDG	i304	i316	Black	White	Red	Yellow
BF Bolt-Nut Set	2/4362	2/7132	2/4923	2/8229	U/0331	U/0632	U/0432	U/0532

ZN - Electro zinc Coating HDG - Hot Dip Galvanized Steel i304/i316 - Stainless Steel AISI i304/i316



BF Washer

PRODUCT IMAGE

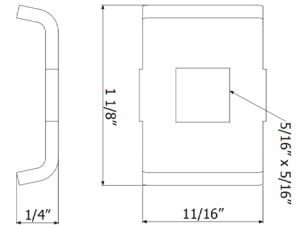
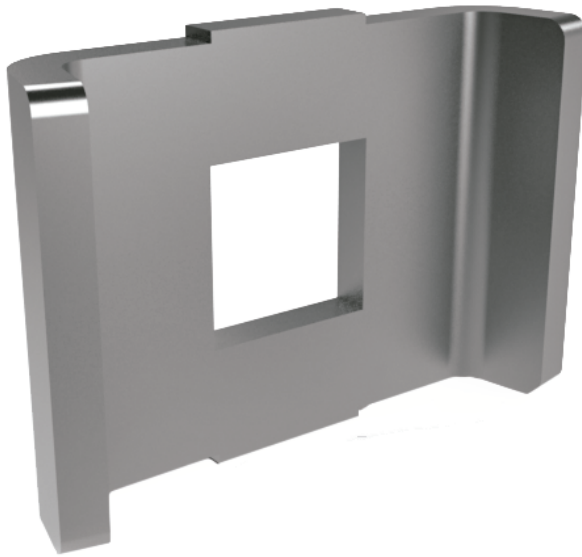

CHARACTERISTICS

Used to attach tray to supports

DESCRIPTION	REF.							
	ZN	HDG	i304	i316	Black	White	Red	Yellow
BF Washer	2/0337	2/0339	2/0340	2/1104	U/0332	U/0633	U/0433	U/0533

ZN - Electro zinc Coating HDG - Hot Dip Galvanized Steel i304/i316 - Stainless Steel AISI i304/i316

SSC Central Suspension and Splice Washer

PRODUCT IMAGE

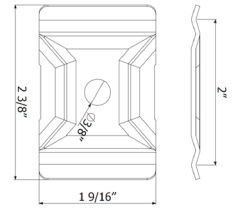
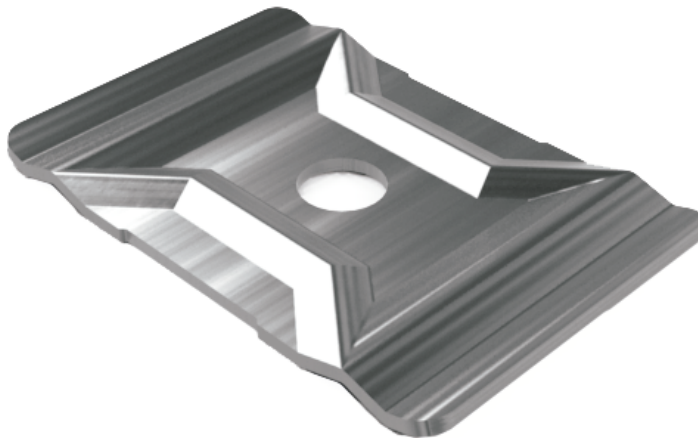

CHARACTERISTICS

Use with threaded rod up to 3/8" diameter
 Each hanging attachment requires:
 Two - SSC and threaded rod fitted with two nuts
 Used as attachment to any support

DESCRIPTION	REF.							
	ZN	HDG	i304	i316	Black	White	Red	Yellow
SSC	2/2064	2/0363	2/0373	UR	U/0333	U/0634	U/0434	U/0534

ZN - Electrozinc Coating HDG - Hot Dip Galvanized Steel i304/i316 - Stainless Steel AISI i304/i316

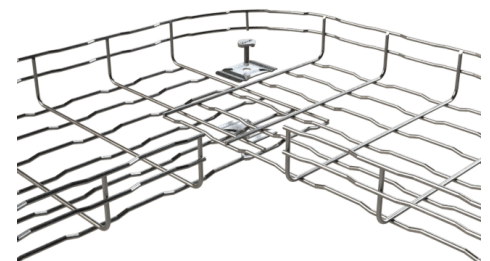
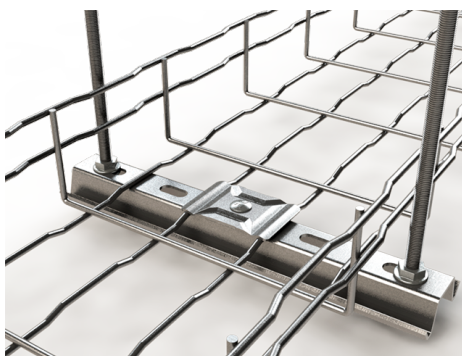

Adjustable Splice Washer Kit

PRODUCT IMAGE

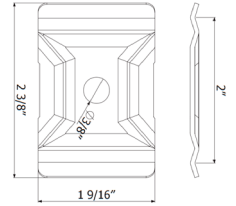

CHARACTERISTICS

Used to create custom bends and sweeps

DESCRIPTION	REF.						
	PG	HDG	i304	Black	White	Red	Yellow
CU BFR/BF2R	2/5059	2/5060	2/5093	U/0344	U/0645	U/0445	U/0545

PG - Pregalvanized HDG - Hot Dip Galvanized Steel i304/i316 - Stainless Steel AISI i304/i316

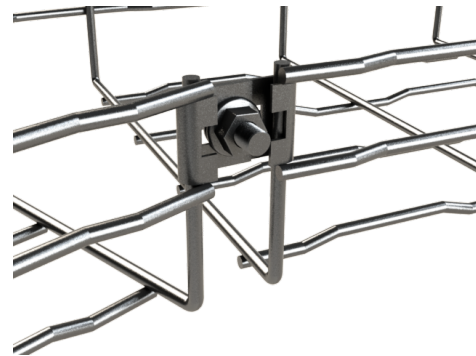

Lateral Splice Set ULA BFR 2"/4"

PRODUCT IMAGE

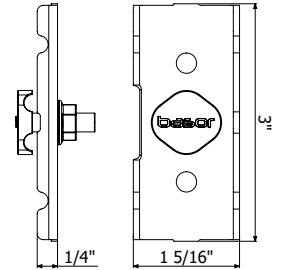

CHARACTERISTICS

Used to splice BFR H2" and BFR H4" tray
Most rigid BasorFil splice
Set includes lateral splice and BF Bolt-Nut Set

DESCRIPTION	REF.						
	ZN	HDG	i304	Black	White	Red	Yellow
Lateral Splice SET ULA 2"/4"	2/4919	2/4363	2/4921	U/0330	U/0631	U/0431	U/0531

ZN - Electro zinc Coating HDG - Hot Dip Galvanized Steel i304/i316 - Stainless Steel AISI i304/i316

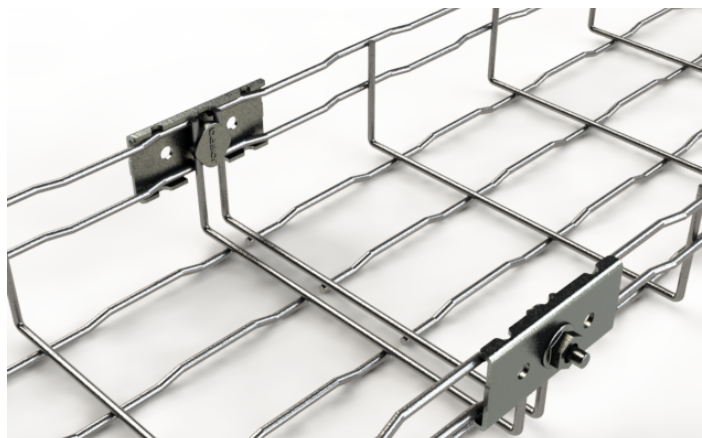

Blind end plate

PRODUCT IMAGE

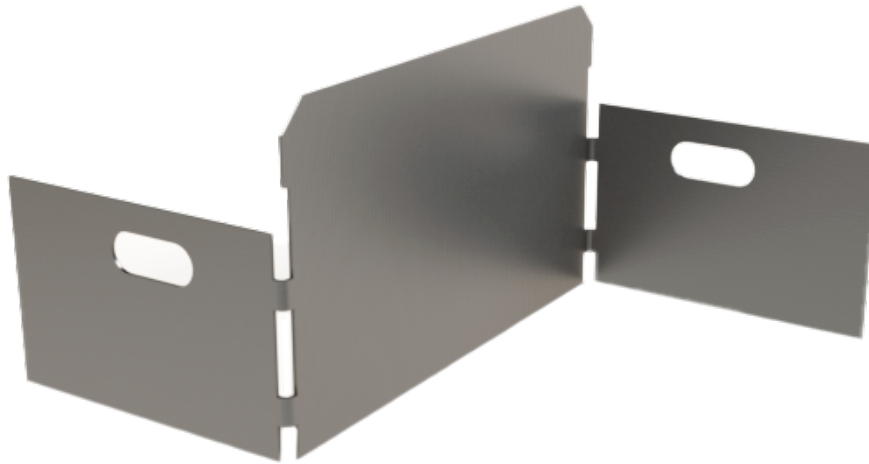

CHARACTERISTICS

Used to block open sections of trays at run ends and width transitions

DESCRIPTION	REF.						
	PG	HDG	i304	Black	White	Red	Yellow
REER 2"x2"	2/6291	2/6299	2/8767	U/0354	U/0655	U/0455	U/0555
REER 4"x2"	2/6295	2/6303	2/8768	U/0355	U/0656	U/0456	U/0556
REER 2"x4"	2/6293	2/6301	-	U/0356	U/0657	U/0457	U/0557
REER 4"x4"	2/6297	2/6305	-	U/0357	U/0658	U/0458	U/0558

PG - Pregalvanized HDG - Hot Dip Galvanized Steel i304/i316 - Stainless Steel AISI i304/i316

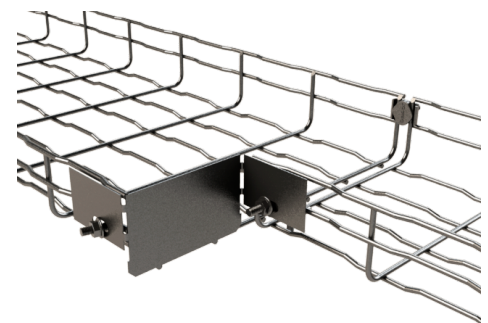
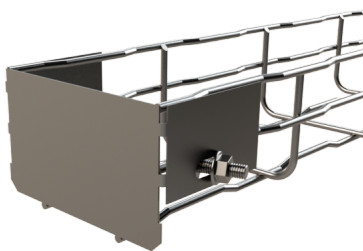

Quick Splice

PRODUCT IMAGE

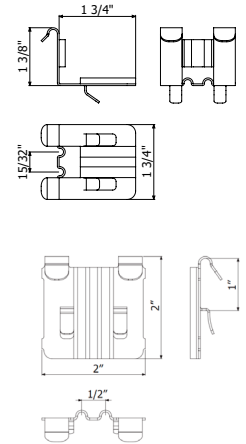

CHARACTERISTICS

Used to splice BFR and E-BFR BasorFil trays

DESCRIPTION	REF.					
	ZN	HDG	Black	White	Red	Yellow
UR BFR H2"/4" E-BFR H4"	2/6217	2/6219	U/0327	U/0628	U/0428	U/0528
UR BFR H1-1/2"/4" E-BFR H2"/4"	2/7271	2/7272	U/0328	U/0629	U/0429	U/0529

ZN - Electro zinc Coating HDG - Hot Dip Galvanized Steel

MOUNTING

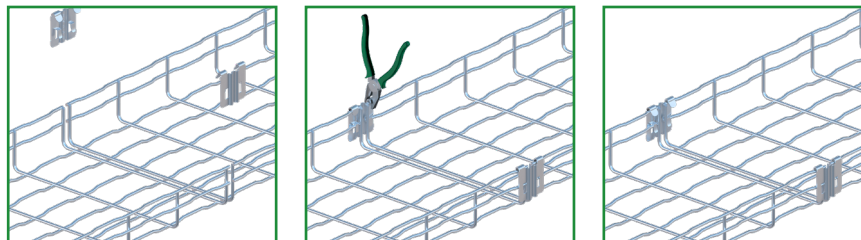

Multi union splice bar

PRODUCT IMAGE

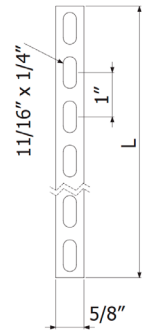
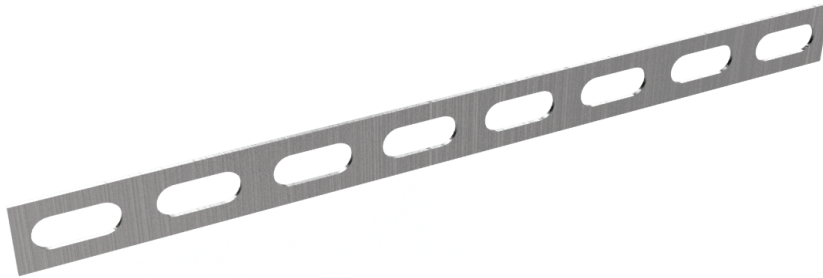

CHARACTERISTICS

Used for splicing two different widths of BasorFil

DESCRIPTION	L	REF.							
		PG	HDG	i304	i316	Black	White	Red	Yellow
MU	11"	2/0357	-	2/9872	2/14244	U/0340	U/0641	U/0441	U/0541
MU 275	20"	2/10007	-	-	-	U/0341	U/0642	U/0442	U/0542

PG - Pregalvanized HDG - Hot Dip Galvanized Steel i304/i316 - Stainless Steel AISI i304/i316

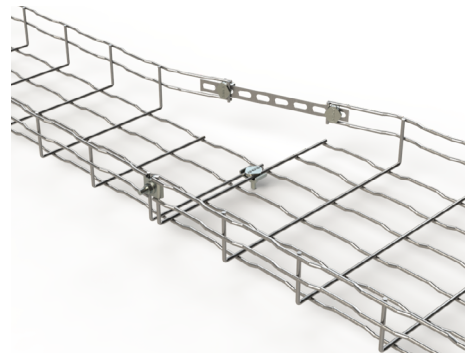

Universal Box support

PRODUCT IMAGE

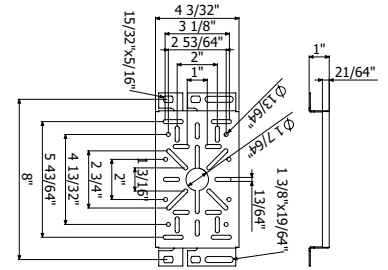
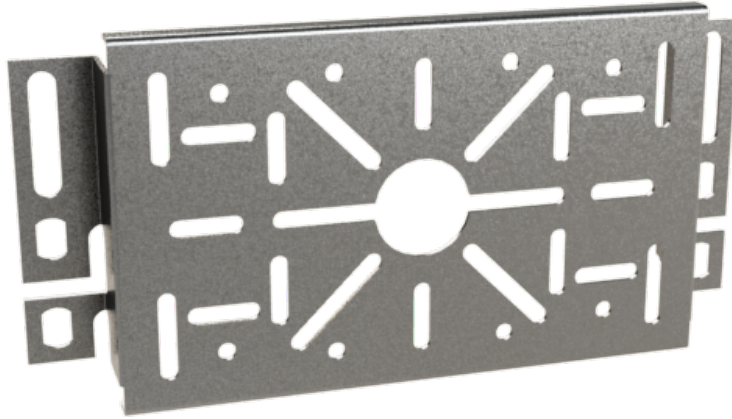

CHARACTERISTICS

For mounting electrical boxes to BasorFil tray

DESCRIPTION	REF.							
	PG	HDG	i304	i316	Black	White	Red	Yellow
Universal Box Support	2/0358	2/0368	2/0378	UR	U/0336	U/0637	U/0437	U/0537

PG - Pregalvanized HDG - Hot Dip Galvanized Steel i304/i316 - Stainless Steel AISI i304/i316

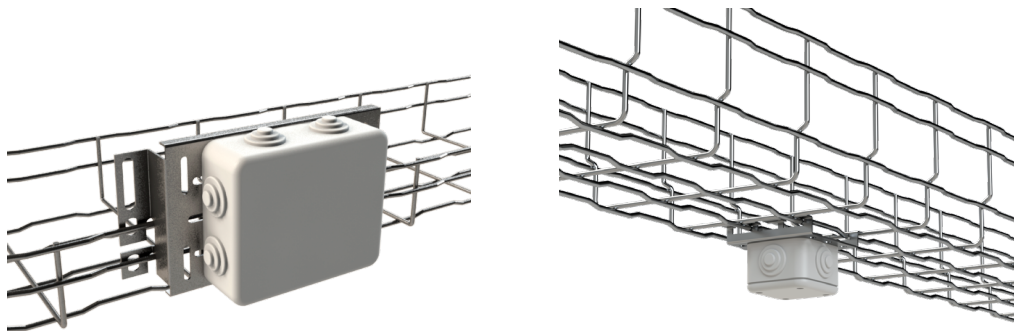

Mini universal support and wall mount

PRODUCT IMAGE

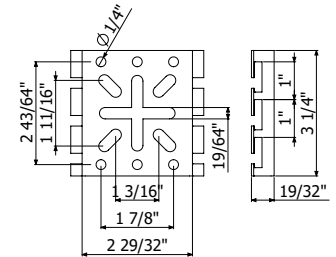
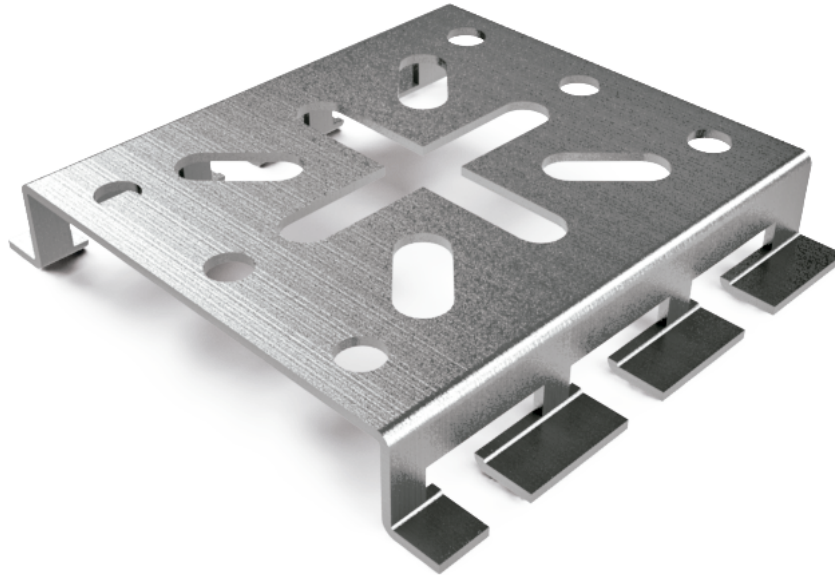

CHARACTERISTICS

For mounting electrical boxes to BasorFil tray
Supports BasorFil BF2R 2"x2" tray to walls

DESCRIPTION	REF.							
	PG	HDG	i304	i316	Black	White	Red	Yellow
Mini Universal Support	2/0359	2/0369	2/0379	UR	U/0337	U/0638	U/0438	U/0538

PG - Pregalvanized HDG - Hot Dip Galvanized Steel i304/i316 - Stainless Steel AISI i304/i316

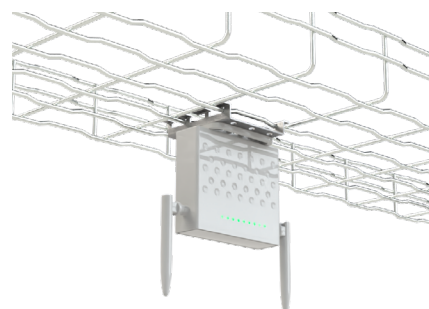
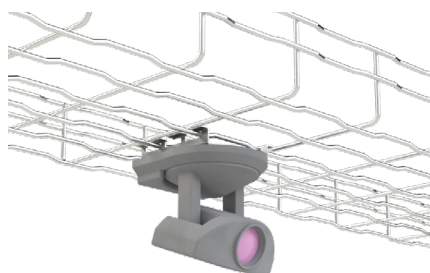
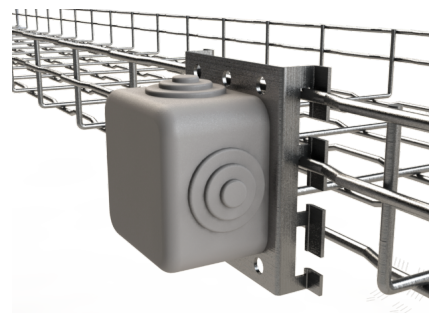

BT-90 Kit

PRODUCT IMAGE

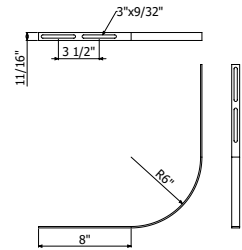

CHARACTERISTICS

For mounting electrical boxes to BasorFil tray

DESCRIPTION	WEIGHT		REF.		
	lbs/unit	kg/ud	PG	Black	White
BT-90 KIT	0.62	0.28	U/008	U/0398	U/0692

MOUNTING

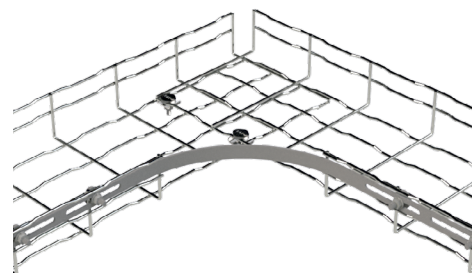
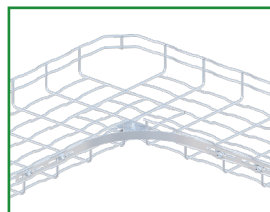
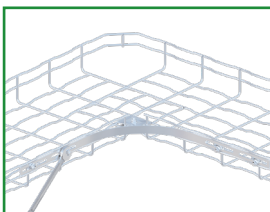
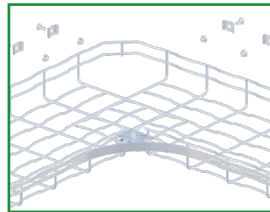
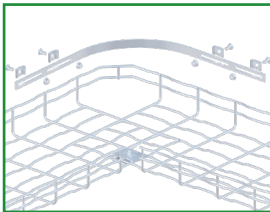

BasorFil derivation PDBFR for H2"/4"/6"

PRODUCT IMAGE

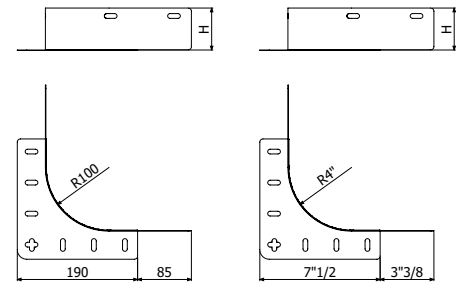
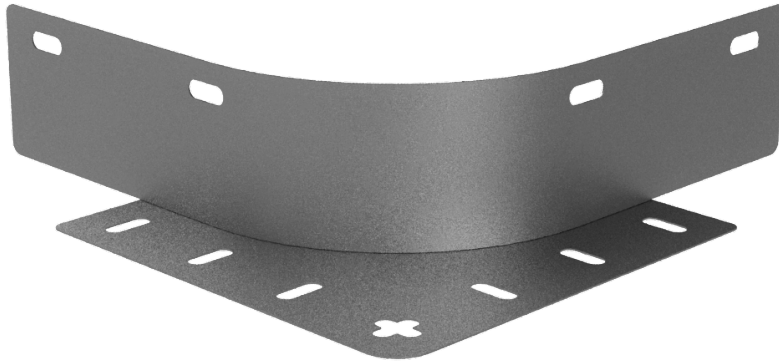

CHARACTERISTICS

Accessory for Wire-mesh basket trays
2"/4"/6" tray depth
4" .. 24" tray width
4" Radius

To be fixed with BF Bolt Staple Set or B1 Bolt and Staple



DESCRIPTION	REF
	PG
Derivation PDBFR H65 (2") PG	225032
Derivation PDBFR H105 (4") PG	225033
Derivation PDBFR H155 (6") PG	225034

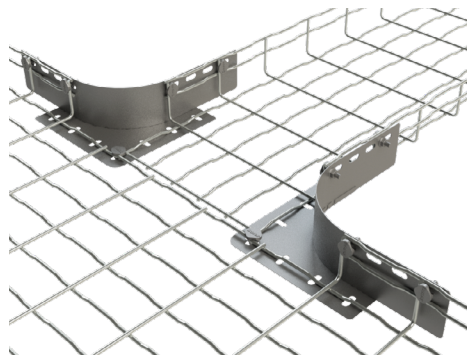

Support SFL 30

PRODUCT IMAGE

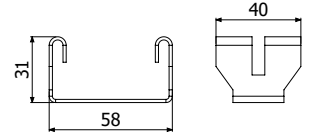
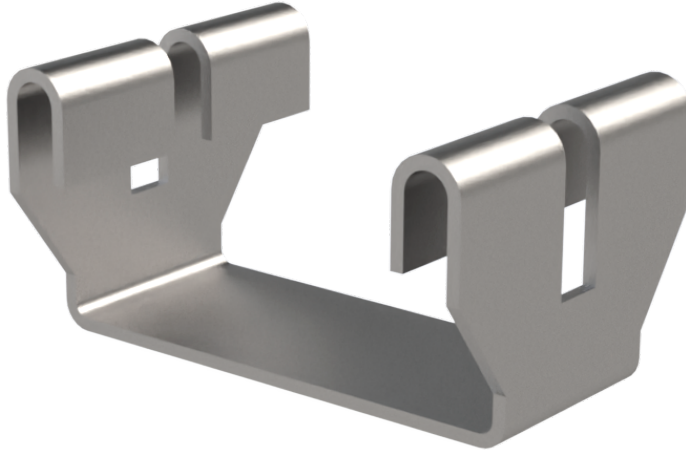

CHARACTERISTICS

Bolts not needed

DESCRIPTION	WEIGHT		REF.
	lbs/unit	kg/ud	PG
Lighting Support SFL 30	0.20	0.09	2/18822



STB2 Conduit connector plate

PRODUCT IMAGE

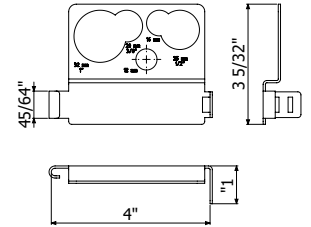
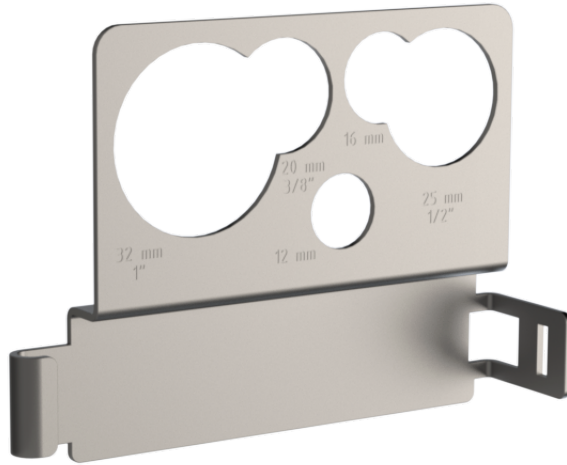

CHARACTERISTICS

Accessory for Wire-mesh basket trays
2" / 4" / 6" tray depth
4" .. 24" tray width
4" Radius

To be fixed with BF Bolt Staple Set or B1 Bolt and Staple

DESCRIPTION	REF
	PG
Derivation PDBFR H65 (2") PG	225032
Derivation PDBFR H105 (4") PG	225033
Derivation PDBFR H155 (6") PG	225034

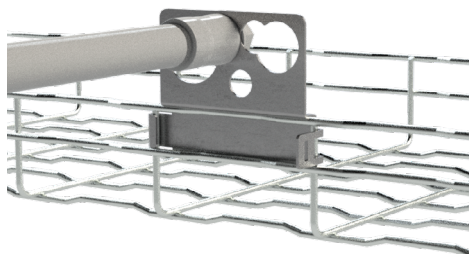

MOUNTING

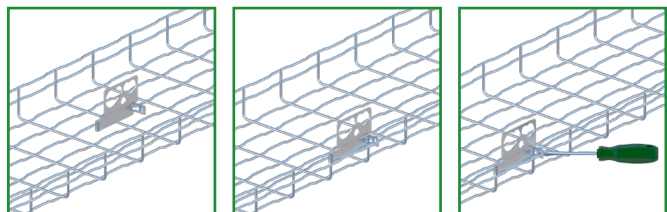

Camera support

PRODUCT IMAGE

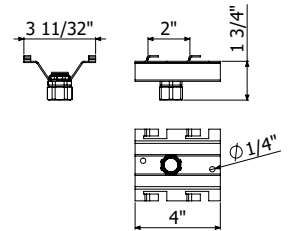
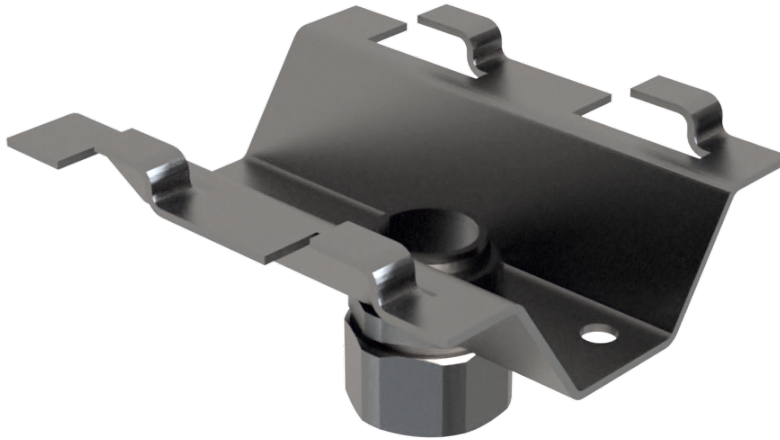

CHARACTERISTICS

No nuts or bolt needed to install
The pipe (conduit) will be supplied by the installer
(The part comes with 1/2" conduit compression splicing nut/bolt)

DESCRIPTION	WEIGHT		REF.
	lbs/unit	kg/ud	PG
Camera support	1	0.45	U/0036



MOUNTING

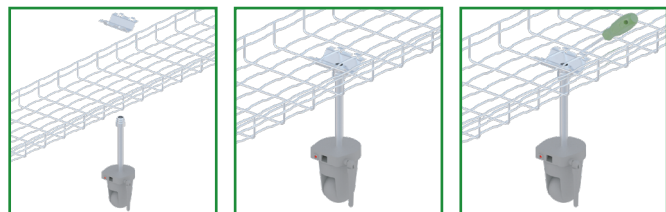

1U Switch Support

PRODUCT IMAGE

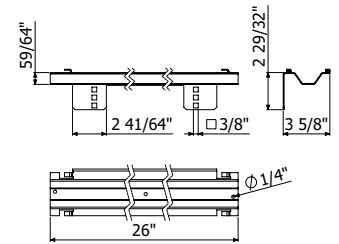
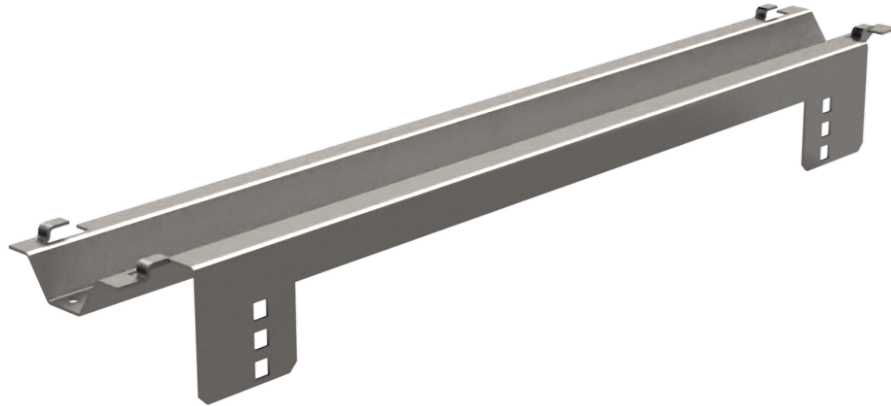

CHARACTERISTICS

No nuts or bolt required for attachment

DESCRIPTION	WEIGHT		REF.
	lbs/unit	kg/ud	PG
1U Switch Support	2.85	1.30	U/0035

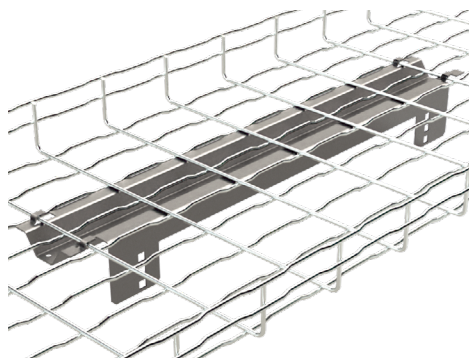

MOUNTING

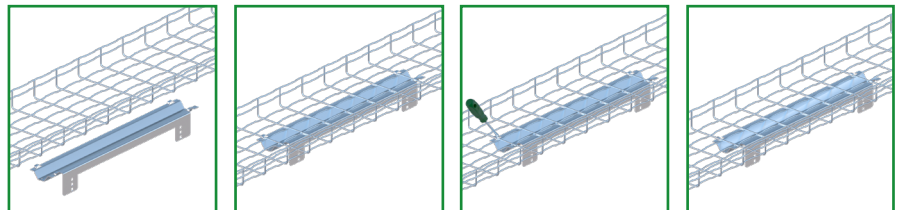

Blind end plate

PRODUCT IMAGE

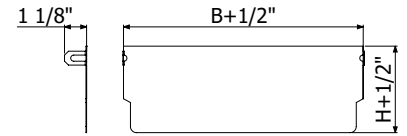
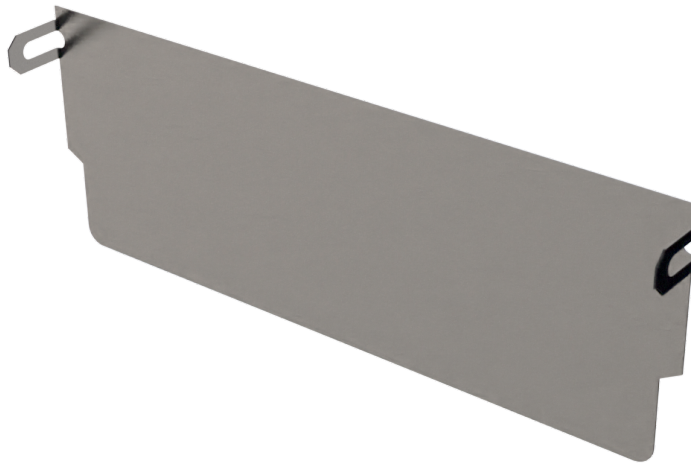

CHARACTERISTICS

No nuts or bolt required for attachment

DESCRIPTION	WEIGHT		REF.
	lbs/unit	kg/ud	PG
Blind End 4x2"	0.142	0.06	U/0044
Blind End 6x2"	0.209	0.10	U/0043
Blind End 8x2"	0.275	0.12	U/0042
Blind End 12x2"	0.409	0.19	U/0041
Blind End 16x2"	0.543	0.25	U/0040
Blind End 18x2"	0.61	0.28	U/0039
Blind End 20x2"	0.677	0.31	U/0038
Blind End 24x2"	0.811	0.37	U/0037
Blind End 4x4"	0.28	0.13	U/0058
Blind End 6x4"	0.41	0.19	U/0057
Blind End 8x4"	0.53	0.24	U/0056
Blind End 12x4"	0.78	0.35	U/0055
Blind End 16x4"	1.03	0.47	U/0054
Blind End 18x4"	1.15	0.52	U/0053
Blind End 20x4"	1.27	0.58	U/0052
Blind End 24x4"	1.52	0.67	U/0051

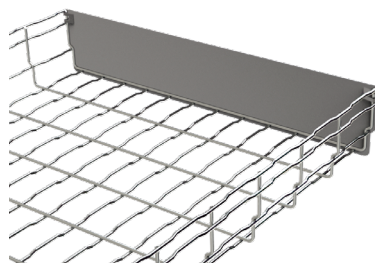

MOUNTING

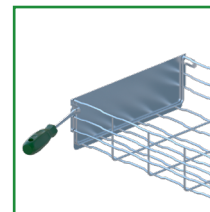
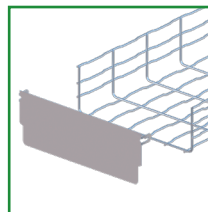

Designation plate DP

PRODUCT IMAGE

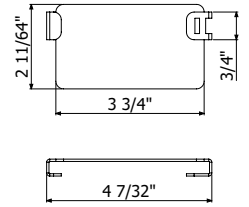
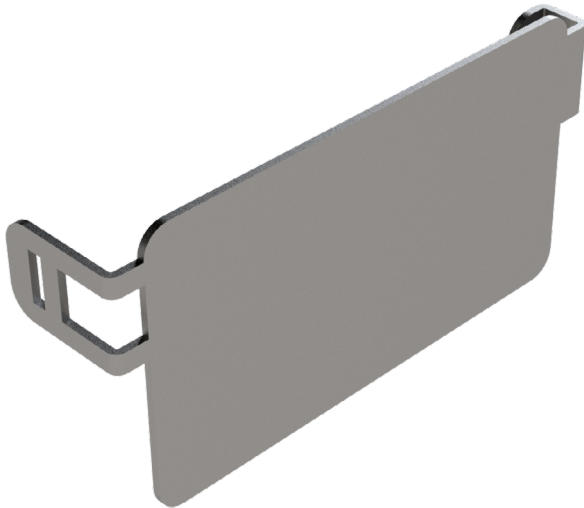

CHARACTERISTICS

Bolts not needed. It is attached by pressing the flanges with a flat screwdriver-

DESCRIPTION	WEIGHT		REF.
	lbs/unit	kg/ud	PG
Designation Plate DP	0.20	0.10	9/02519

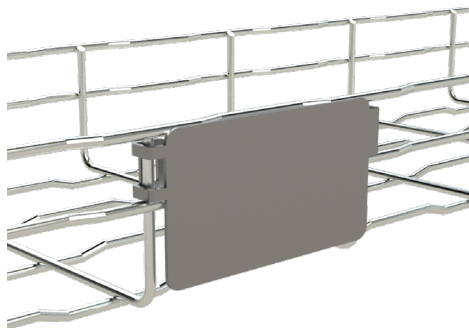

MOUNTING

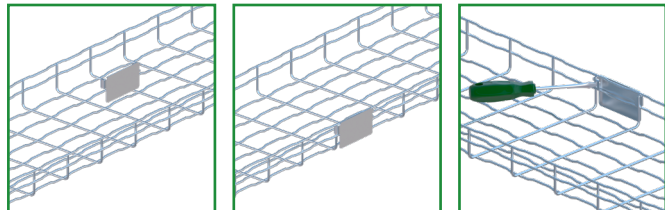

Hinged Splice

PRODUCT IMAGE

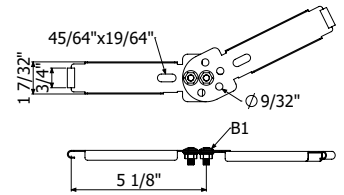
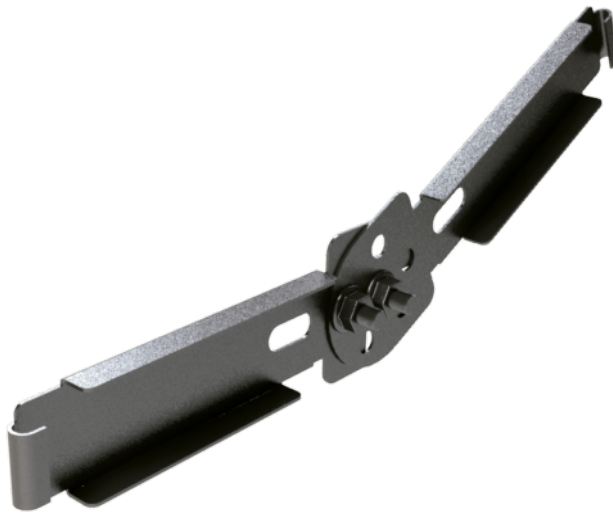

CHARACTERISTICS

Used for changes in elevation
Adjusts to any angle

DESCRIPTION	REF.					
	PG	i304	Black	White	Red	Yellow
JUA-BFR 2"/4"	2/9868	2/9869	U/0342	U/0643	U/0443	U/0543

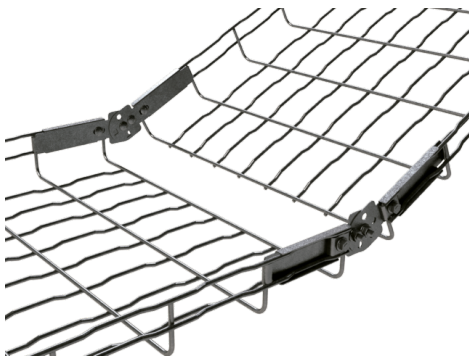

MOUNTING



Drop-Out Plate

PRODUCT IMAGE

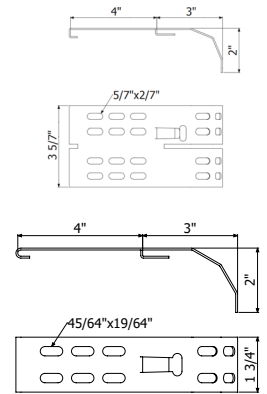

DESCRIPTION	WEIGHT		REF.			
	lbs/unit	kg/ud	PG	Black	White	Red
BF/BFR Drop-Out Plate	0.44	0.21	2/6451	U/0338	U/0639	2/6452
BF/BFR Mini Drop-Out Plate	0.25	0.12	2/9807	U/0339	U/0640	-
BF/BFR XL Drop-Out Plate	0.25	0.12	U/0022	-	-	-

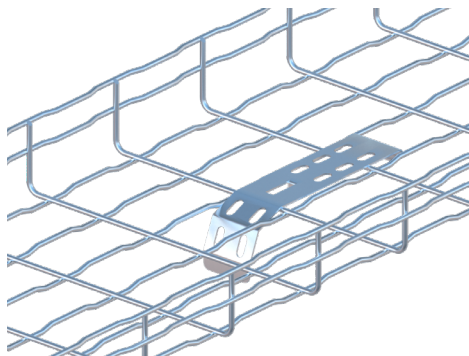

MOUNTING

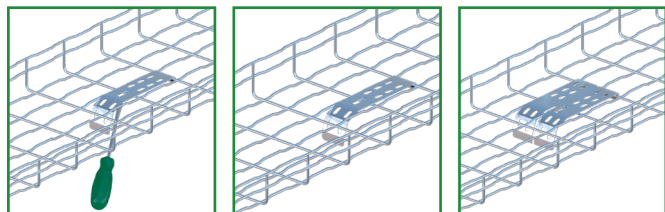

BJCBFR Drop-Out Sideway

PRODUCT IMAGE

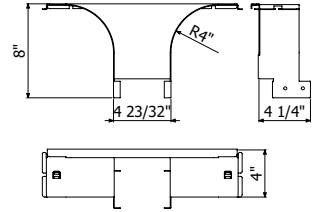
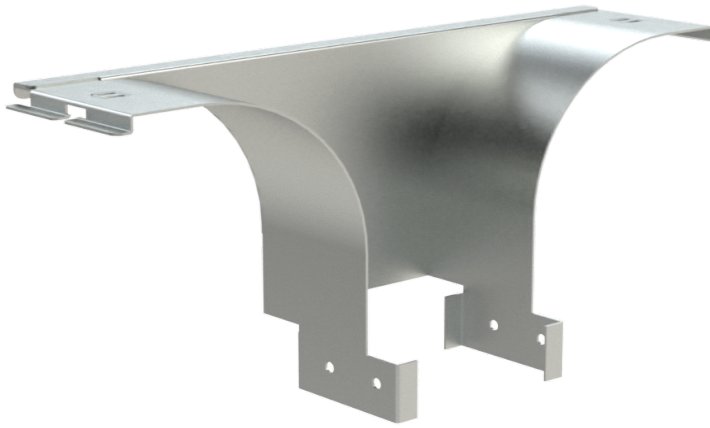

DESCRIPTION	WIDTH (W)		WEIGHT		REF.		
	in	mm	lbs/unit	kg/ud	PG	Black	White
BJCBFR Drop-Out Sideway 4"x4"	8"	200	2.03	0.93	2/18813	U/1339	U/1629

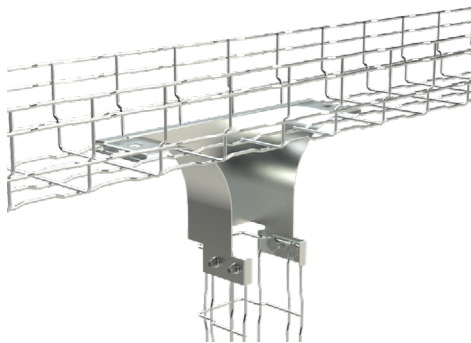

MOUNTING

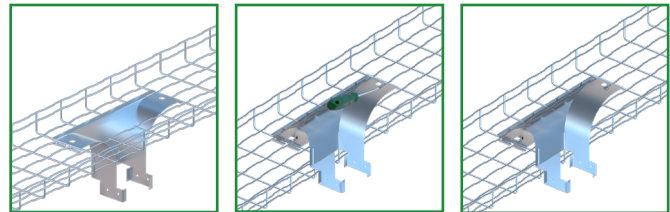

BJCL Drop-Out Sideway

PRODUCT IMAGE

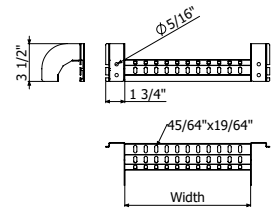
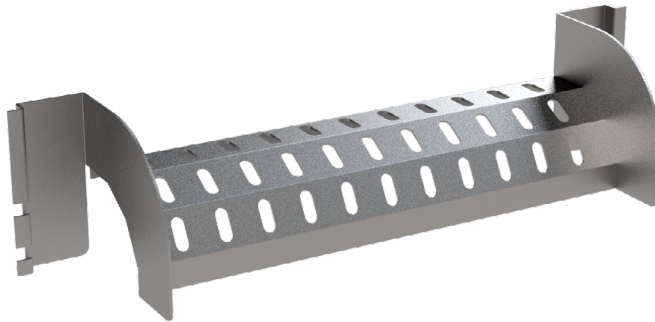

DESCRIPTION	WIDTH (W)		WEIGHT		REF.		
	in	mm	lbs/unit	kg/ud	PG	Black	White
BJCL Drop-Out Sideway 8"	8"	200	0.99	0.44	2/18777	U/1334	U/1642
BJCL Drop-Out Sideway 12"	12"	300	1.21	0.54	2/18778	U/1335	U/1643
BJCL Drop-Out Sideway 18"	18"	450	1.54	0.69	2/18779	U/1336	U/1644
BJCL Drop-Out Sideway 24"	24"	600	1.87	0.84	2/18780	U/1337	U/1645

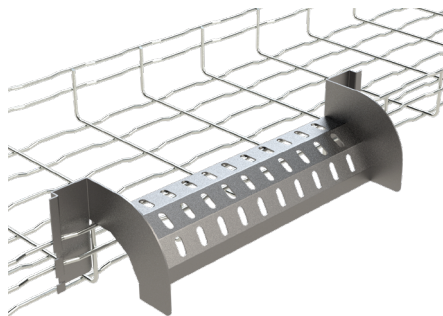

MOUNTING

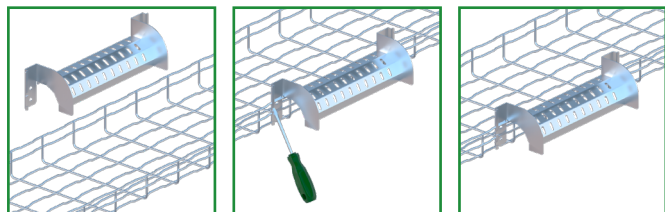

Grounding Lug

PRODUCT IMAGE

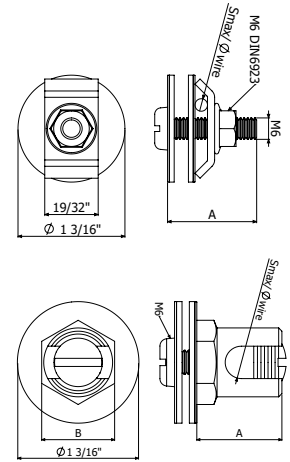
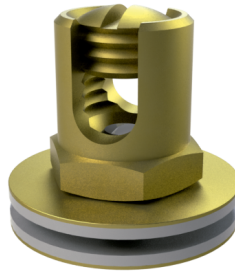
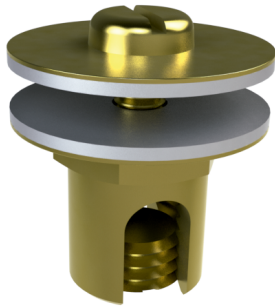

DESCRIPTION	AWG	SMAX		WEIGHT		REF.
		inch ²	mm ²	lbs/unit	kg/ud	LTN
Grounding TT 35 M6x0.47"	2	0.054	35	0.09	0.04	2/6796
Grounding TT 95 M6x0.47"	8	0.147	95	0.17	0.07	2/6797
TTL 10-35	2	0.054	35	0.06	0.02	2/8189

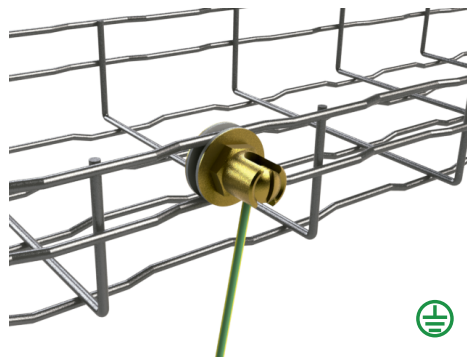

Strut Connection Strip

PRODUCT IMAGE

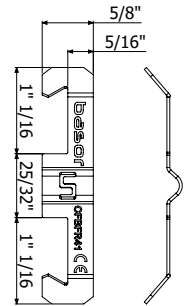
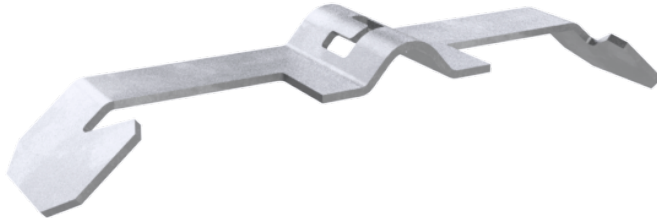

DESCRIPTION	WEIGHT		REF.			
	lbs/unit	kg/ud	SS304	Black	White	SS316
CFBFR41	0.02	0.009	2/10284	U/1304	U/0699	2/18567

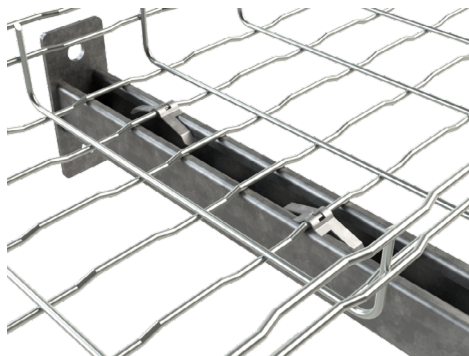

MOUNTING

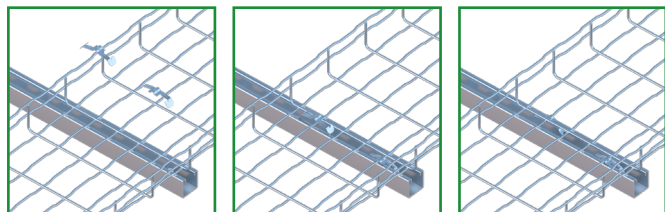

Trapeze Hanger Clip

PRODUCT IMAGE

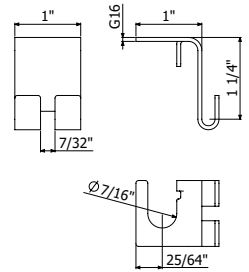

DESCRIPTION	WEIGHT		REF.		
	lbs/unit	kg/ud	PG	Black	White
Trapeze Hanger Clip SST	0.04	0.02	2/5724	U/0345	U/0693

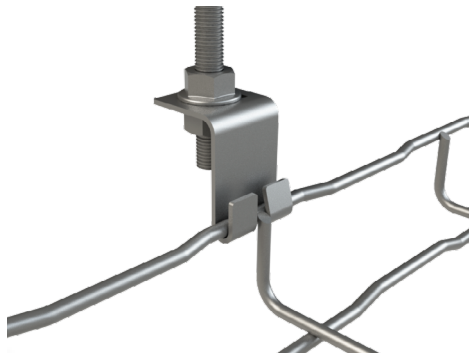

MOUNTING

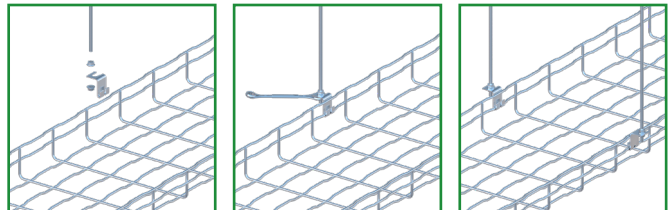

C-SVO Center Hanger

PRODUCT IMAGE

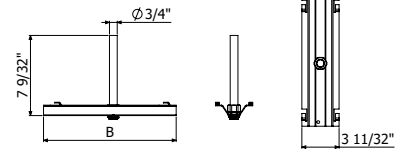

DESCRIPTION	LENGTH		WEIGHT		REF.		
	in	mm	lbs/unit	kg/ud	PG	Black	White
C-SVO Center Hanger Support 4"/6"/8"	4"/6"/8"	100/150/200	1.5	0.68	U/0029	U/1309	U/0695
C-SVO Center Hanger Support 12"/16"	12"/16"	300/400	2	0.90	U/0030	U/1310	U/0696
C-SVO Center Hanger Support 18"	18"	450	2.5	1.13	U/0031	U/1311	U/0697
C-SVO Center Hanger Support 20"/24"	24"	600	2.5	1.13	U/0032	U/1312	U/0698

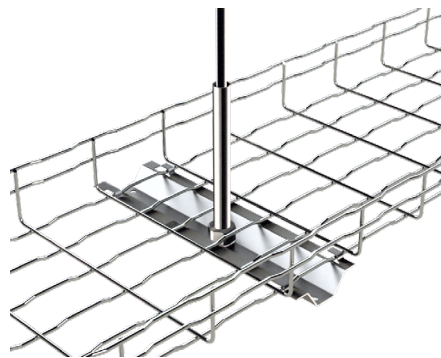

L-Bracket Wall Mount

PRODUCT IMAGE

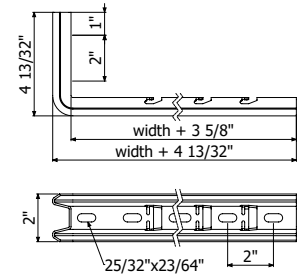

DESCRIPTION	WIDTH		SWL		REF.					
	inch	mm	Lbs	kg	PG	HDG	SS304	SS316	Black	White
C-SHO 4"/6"	1.5"	0.68	1.5	0.68	2/7230	2/7239	2/7490	2/17824	U/0358	U/0659
C-SHO 8"	2"	0.90	2	0.90	2/7232	2/7241	2/7492	2/17825	U/0360	U/0661
C-SHO 12"	2.5"	1.13	2.5	1.13	2/7233	2/7241	2/7493	2/17826	U/0361	U/0662
SHO/SHOT Piece	2.5"	1.13	2.5	1.13	2/6240	2/6318	-	2/18479	-	-



MOUNTING

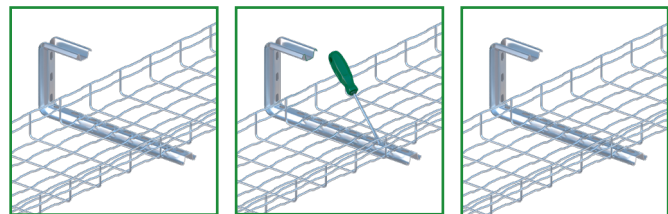

SRB Wall Support

PRODUCT IMAGE

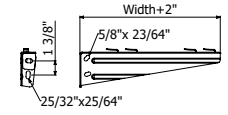

SRB Support 4" / 6" / 8" / 12" / 16"

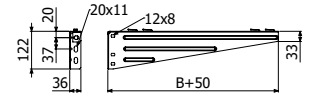

SRB Support 18" / 20" / 24"

DESCRIPTION	WIDTH		SWL		REF.			
	inch	mm	Lbs	kg	PG	HDG	Black	White
C-SHO 4"/6"	4"	100	155	70	2/6372	2/6379	U/0362	U/0663
C-SHO 8"	6"	150	133	60	2/6373	2/6380	U/0363	U/0664
C-SHO 12"	8"	200	133	60	2/6374	2/6381	U/0364	U/0665
SHO/SHOT Piece	12"	300	133	60	2/6375	2/6382	U/0365	U/0666
C-SHO 4"/6"	16"	400	133	60	2/6376	2/6383	U/0366	U/0667
C-SHO 8"	20"	500	133	60	2/6377	2/6384	U/0367	U/0668
C-SHO 12"	24"	600	133	60	2/6378	2/6385	U/0368	U/0669

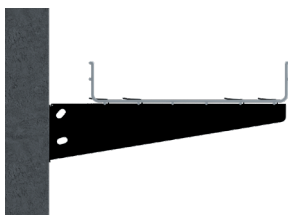

MOUNTING

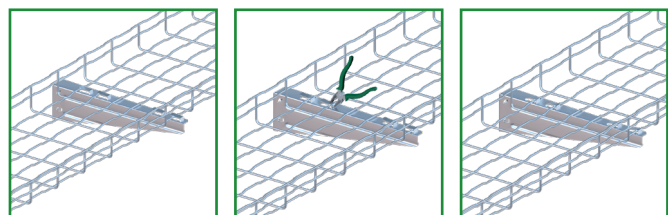

SV Floor & Wall Support

PRODUCT IMAGE

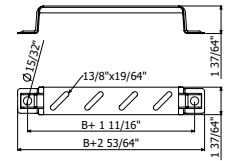
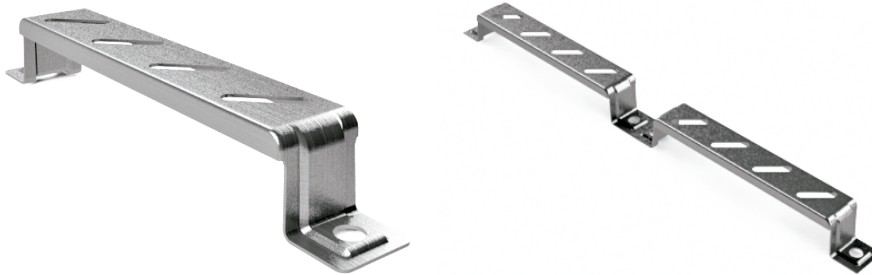

SV 4" / 6" / 8" / 12"

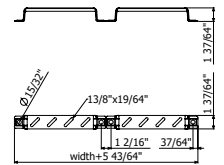

SV 16" / 20" / 24"

DESCRIPTION	B		SWL		REF.				
	inch	mm	Lbs	kg	PG	HDG	SS304	Black	White
SV 4"	4"	100	609	276	2/1046	2/1050	2/1062	U/0384	U/0679
SV 6"	6"	150	573	260	2/1047	2/1051	2/1063	U/0385	U/0680
SV 8"	8"	200	558	253	2/1048	2/1052	2/1064	U/0386	U/0681
SV 12"	12"	300	456	207	2/1049	2/1053	2/1065	U/0387	U/0682
SV 16"	16"	400	1116	506	2/3413	2/3418	-	U/0388	U/0683
SV 18"/20"	20"	500	1014	460	2/3414	2/3419	-	U/0389	U/0684
SV 24"	24"	600	912	414	2/3415	2/3420	-	U/0390	U/0685

MOUNTING

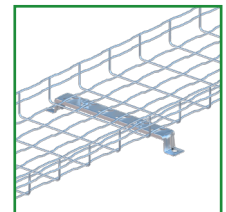
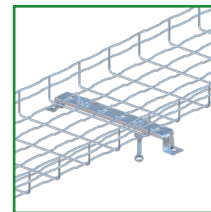
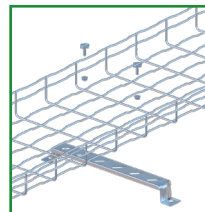

PBFR Under Floor Support

PRODUCT IMAGE

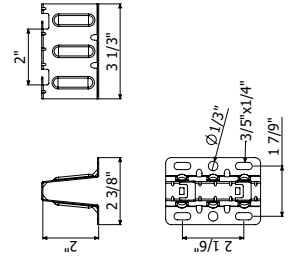
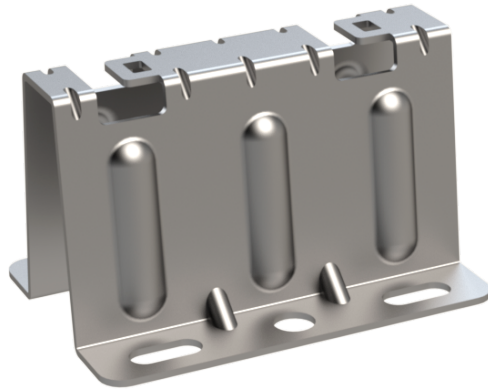

DESCRIPTION	H		REF.			
	inch	mm	PG	HDG	SS304	SS316
PBFR Support	2"	50	2/5590	2/4397	2/8777	2/18565

Base 4"/6"/8" →  1 SUPPORT NEEDED

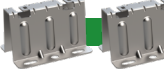

Base 12"/16" →  2 SUPPORTS NEEDED

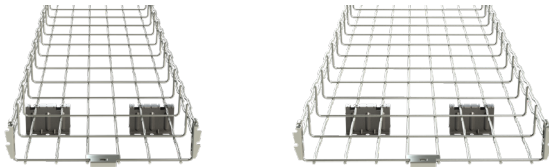

Base 18"/20"/24" →  2 SUPPORTS NEEDED

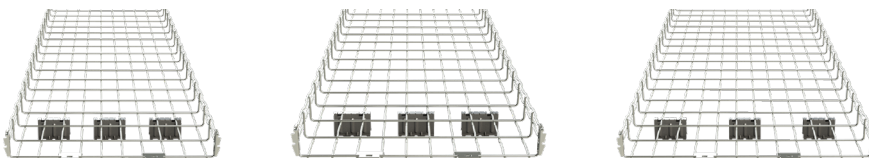

MOUNTING

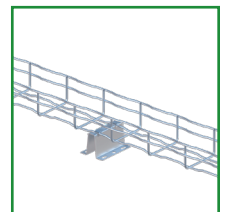
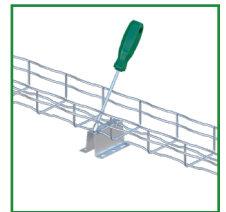
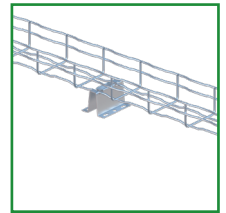

Kit SFS 2"/5"

PRODUCT IMAGE

Kit SFS 2"

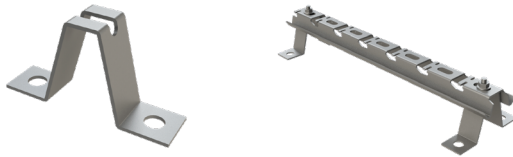
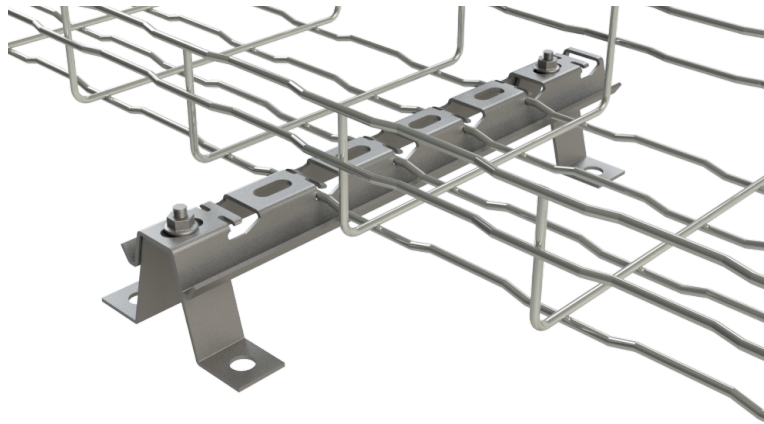

DESCRIPTION	Width		REF.
	inch	mm	PG
Kit SFS 2".4"	4"	100	U0260
Kit SFS 2".6"	6"	150	U0261
Kit SFS 2".8"	8"	200	U0262
Kit SFS 2".12"	12"	300	U0263
Kit SFS 2".16"	16"	400	U0264
Kit SFS 2".20"	20"	500	U0265
Kit SFS 2".24"	24"	600	U0266

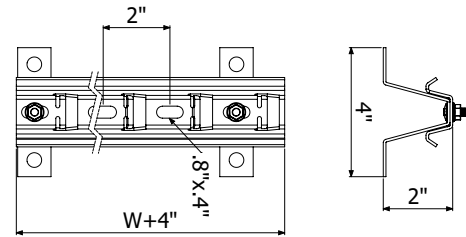

PRODUCT IMAGE

Kit SFS 5"

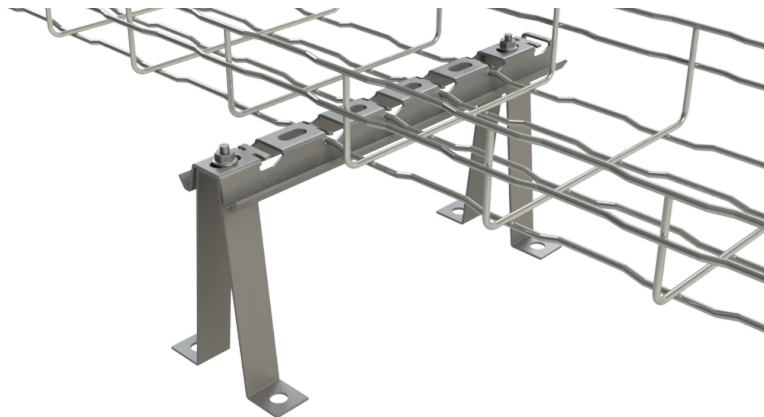

DESCRIPTION	Width		REF.
	inch	mm	PG
Kit SFS 5".4"	4"	100	U0270
Kit SFS 5".6"	6"	150	U0271
Kit SFS 5".8"	8"	200	U0272
Kit SFS 5".12"	12"	300	U0273
Kit SFS 5".16"	16"	400	U0274
Kit SFS 5".20"	20"	500	U0275
Kit SFS 5".24"	24"	600	U0276

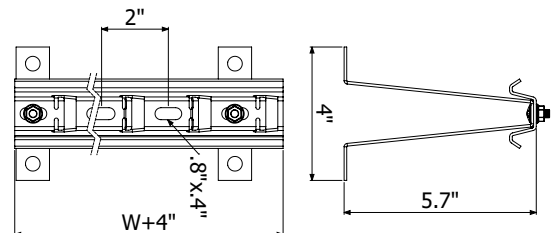

C-SVO Support Profile

PRODUCT IMAGE

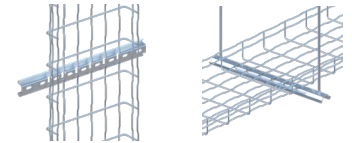
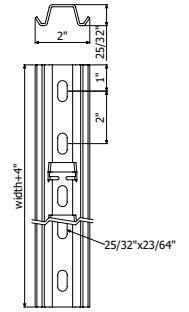

DESCRIPTION	Height		Width		SWL		REF.					
	inch	mm	inch	mm	Lbs	kg	PG	HDG	SS304	SS316	Black	White
C-SVO 4"+6"	-	-	4"	100	552	250	2/3630	2/6208	2/6285	2/18421	U/0370	U/0671
C-SVO 8"	-	-	8"	200	649	294	2/1074	2/1079	2/1088	2/18423	U/0372	U/0673
C-SVO 12"	-	-	12"	300	519	235	2/1076	2/1081	2/1090	2/18424	U/0373	U/0674
C-SVO 16"	-	-	16"	400	355	161	2/3629	2/5719	2/6286	2/18425	U/0374	U/0675
C-SVO 18"	-	-	18"	450	355	115	2/1075	-	-	-	U/0377	U/0678
C-SVO 20"	-	-	20"	500	254	115	2/1077	2/1082	2/6287	2/18426	U/0375	U/0676
C-SVO 24"	-	-	24"	600	192	87	2/5941	2/5720	2/6288	2/18427	U/0376	U/0677
C-SVO 10FT	-	-	-	-	-	-	2/1101	2/7436	-	-	-	-

MOUNTING

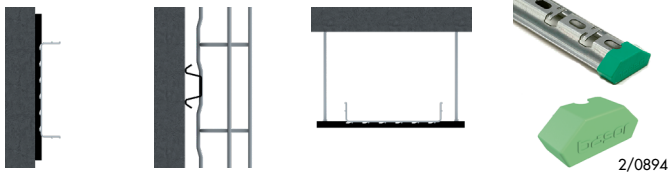

C-SVO2 Support Profile

PRODUCT IMAGE

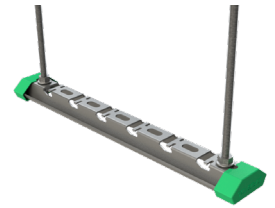
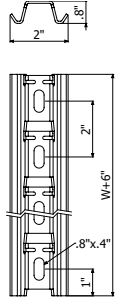

DESCRIPTION	Width		REF.
	inch	mm	PG
KIT STS 4"	4"	100	U/1670
KIT STS 6"	6"	200	U/1671
KIT STS 8"	8"	300	U/1672
KIT STS 12"	12"	400	U/1673
KIT STS 16"	16"	450	U/1674
KIT STS 20"	20"	500	U/1675
KIT STS 24"	24"	600	U/1676

Wall Support

PRODUCT IMAGE

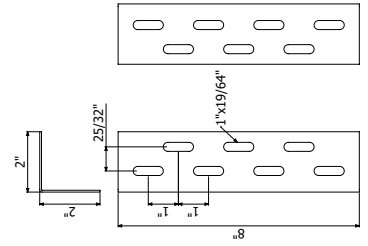
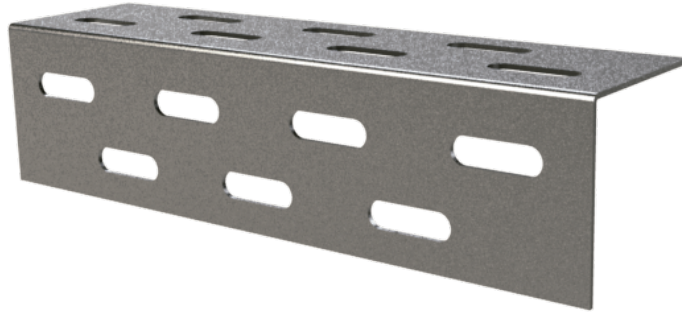

DESCRIPTION	WEIGHT		REF.		
	lbs/unit	kg/ud	PG	Black	White
Wall Support	0.53	0.24	2/8228	U/0343	U/0644

MOUNTING

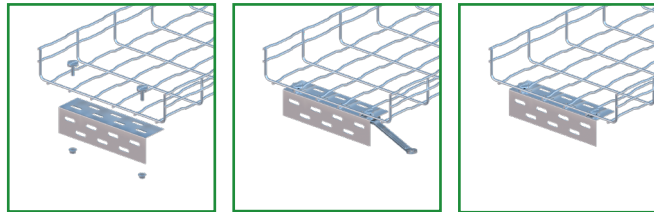

Basor Roller System

CABLE PULLING ROLLER SYSTEM FOR FIBER, COPPER, MC/VNTC CABLES

The Basor Roller System is a versatile tool to keep cables free of sharp bends and kinks with reducing wear to cable sheathing. Rollers can be snapped-in the heavy-duty frame or removed when needed. Large 4"x4" opening can handle multiple cable bundles.

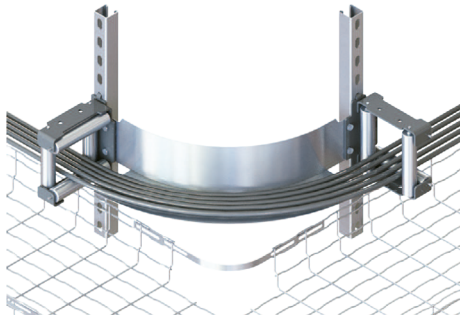

6" Radius cable guide is useful in tight radius bends for copper cabling.

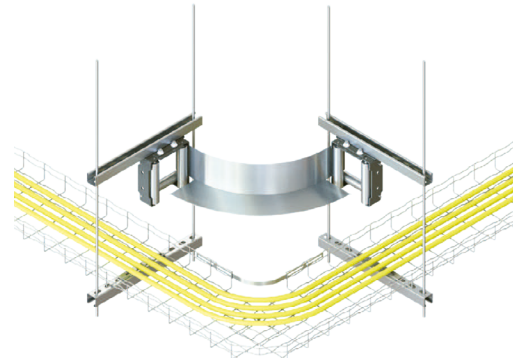

Basor Roller handles fiber optic cables with care when used in conjunction with 6"R and 12"R cable guide.

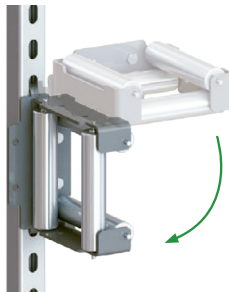

Basor Roller attaches directly to slotted strut without additional clamps or hardware.

DESCRIPTION	HEIGHT	WIDTH	OPENING	RADIUS
Basor Roller	8"	8"	4"x4"	0.7"
Basor 6 Guide	8"	5"	-	6"
Basor 12 Guide	8"	5"	-	12"

Basor Roller System

CABLE PULLING ROLLER SYSTEM

Basor Roller can be a permanent part of any cable management pathway.

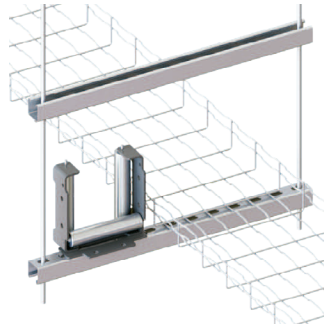
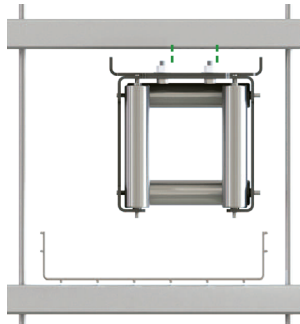

Top roller can be removed for easier install or removal of cables.

HOW TO REMOVE THE ROLLERS

Basor Rollers can be removed without the use of tools.

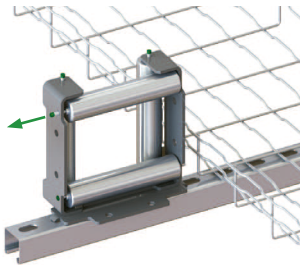

Pull out spring-loaded pin indicated by the green end.

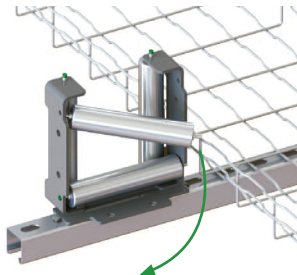

Opposite side of roller will no longer be seated and can be removed.

